

# GERDA®



**DOORS  
NTT REVO  
TT OPTIMA**



## DOOR + GOOD ASSEMBLY = **CUSTOMER SATISFACTION**

At GERDA, we care not only about delivering superb products and highest quality safety technologies – we want to provide our customers with professional maintenance services. Proper installation of our products guarantees success and customer satisfaction, which is why we encourage all installers to participate in training courses organised by the GERDA Academy.

The purpose of training is to provide thorough knowledge in the design and professional installation of GERDA products to those who want to develop their skills and provide services of the highest quality.

In order to ensure the highest possible quality of services, GERDA will recommend the best-trained installers to its Customers as part of the Good Installation program.



# 3 YEARS WARRANTY

# TABLE OF CONTENTS

GERDA ACADEMY	<b>2</b>
OUR COMPANY	<b>4-5</b>
WHAT YOU SHOULD KNOW ABOUT GERDA DOORS	<b>6</b>
THINGS TO REMEMBER WHEN CHOOSING A DOOR	<b>7</b>
CONSTRUCTION OF NTT REVO DOORS	<b>8-11</b>
DESIGNS OF NTT REVO DOORS	<b>12-13</b>
CONSTRUCTION OF TT OPTIMA DOORS	<b>14-17</b>
DESIGNS OF TT OPTIMA DOORS	<b>18-19</b>
NTT REVO AIR GLASS	<b>20-25</b>
NTT REVO QUADRO	<b>26-37</b>
NTT REVO ELITE 3D	<b>38-40</b>
NTT REVO TEMPO	<b>41-45</b>
TT OPTIMA TEMPO	<b>41-59</b>
TT OPTIMA CLASSIC	<b>60-66</b>
COLOURS	<b>67</b>
DUO DOORS	<b>68</b>
FANLIGHTS	<b>69-71</b>
ACCESSORY SETS	<b>72-73</b>
OPTIONAL ACCESSORIES	<b>74-75</b>
DOOR AND FRAME SIZES	<b>76-77</b>
GERDA LAYERED INSTALLATION	<b>78</b>
GERDALOCK V3	<b>79</b>

# ABOUT US

GERDA IS:

# 30 YEARS OF EXPERIENCE

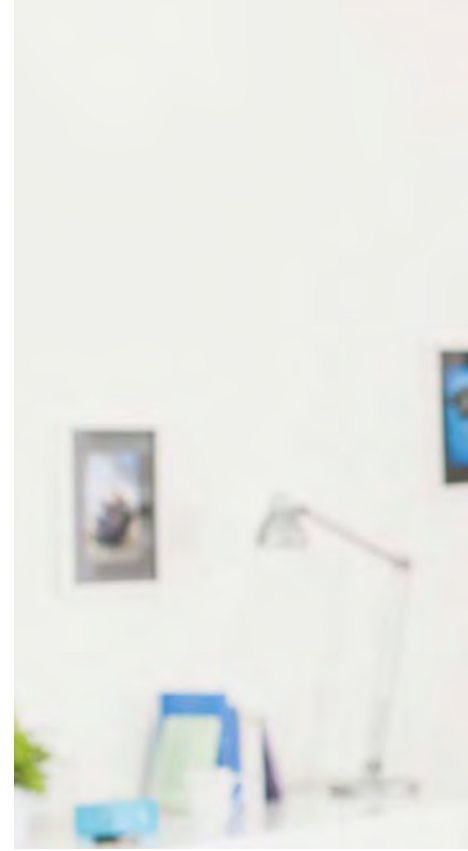

## PEOPLE

We know that we wouldn't have been able to achieve our leading position in the safety technology market without our people and their passion. The experience and creative commitment of our engineers and designers guarantee the highest level of quality, safety and unique design of our products.

We employ 500 employees at three manufacturing sites in Warsaw, Sokołów and Starachowice.



## QUALITY

We deliver products with unique, innovative and patented solutions. The legendary durability and reliability of GERDA products are guaranteed and confirmed by certificates held by our company.

When testing the safety of our products, we collaborate with the Anti-Terrorist Operations Bureau at the Main Police Headquarters.



## COMFORT

Thanks to our professional customer service that includes free measurements, expert advice and installation by authorised professionals, we provide you with a sense of comfort and ease.



## MANUFACTURE

We do business in an aware and responsible manner. We take inspiration from nature when creating our extensive range of designs and colours, and we show our gratitude by caring for the environment through recycling and reusing materials.

## AWARDS AND RECOGNITION



# WHAT YOU SHOULD KNOW ABOUT GERDA DOORS



## THERMAL INSULATION

The heat penetration rate (Ud) determines how much heat Energy will penetrate through the door (including the frame). Based on this parameter, you can calculate heat losses separately for of each compartment. Even a small loss will translate into a higher heating bill. The value of this parameter depends on the type and thickness of the material that the doors are made of. Internal GERDA doors meet the standards applicable since January 1st, 2017, as well as those scheduled to come into force in 2021, thanks to the use of modern technologies and door frames made of steel and wood or aluminium.

Depending on the components used, GERDA doors may reach various levels of insulating properties.

There are three types of doors:

- insulating doors,
- energy-efficient doors,
- passive doors.



No insulation

1,5 W/m<sup>2</sup>K

1,0 W/m<sup>2</sup>K

The basic doors in the insulating range have a heat penetration rate of 1.2 W/m<sup>2</sup>K. They are fitted with a steel PERFOTHERM® frame with thermal perforation, a seal and three possible types of thresholds: steel threshold with a PVC seal, a wooden threshold with a seal and PVC sill, an aluminium threshold with a seal and sill.

Energy-efficient NTT60 doors have a heat penetration rate of between 0.87, when using an ALUTHEM warm aluminium frame with a filled-in thermal chamber and seal, and 1.0 W/m<sup>2</sup>K, when choosing a DUOTHERM warm steel and wood frame with thermal perforation and a seal.

The primary role of passive doors is to save as much energy as possible while simultaneously improving the comfort of living. They enable the accumulation of energy inside the room, directly allowing to save costs. NTT 75 doors have a heat penetration rate of between 0.77 W/m<sup>2</sup>K and 0.94 W/m<sup>2</sup>K, based on the type of frame used.



## BURGLARY RESISTANCE

Burglary resistance is a parameter used to describe doors commonly referred to as anti-burglary doors. Such doors have a special, durable design meant to prevent burglars from cutting a hole in them and preventing unauthorised entry. As a standard, GERDA doors are equipped with two durable locks with a multi-point locking system. Interlocking door bolts, meant to prevent the door leaf from being broken down or taken off its hinges, constitute an important component of the door. GERDA NTT doors are tested for being burglar-proof and their burglary resistance classes are RC2 to RC3. Using a higher-class door will increase the level of security of the people and property inside the house.



**No tools:**  
resistant to attempts made to break down the door by hitting with the shoulder or kicking it, trying to lift it off its hinges or tear out the lock



**4 tools:**  
bolt, pliers, wedge, hammer



**5 tools:**  
steel crowbar, additional screwdriver, nail driver, hammer, electric drill



# THINGS TO KEEP IN MIND WHEN CHOOSING A DOOR

1.



## CHOOSE THE DESIGN THAT BEST FITS YOUR NEEDS

NTT REVO 75 → p. 9  
 NTT REVO 60 → p. 11  
 TT OPTIMA 60 → p. 15  
 TT OPTIMA 50 → p. 17

2.



## CHOOSE A DOOR DESIGN FROM OUR WIDE RANGE OF PRODUCTS

NTT REVO:  
 AIR GLASS → p. 20-25  
 QUADRO → p. 26-37  
 ELITE 3D → p. 38-40  
 TEMPO → p. 41-45

TT OPTIMA:  
 TEMPO → p. 41-59  
 CLASSIC → p. 60-66

3.

Size	Frame model	DOORS		FRAMES	
		Leaf height at the rabbet (H <sub>S</sub> )	Leaf width at the rabbet (S <sub>P</sub> )	Total frame height (H <sub>C</sub> )	Total frame width (S <sub>C</sub> )
80N	TT Optima 50 FB	2025 mm	782 mm	2076 mm	866 mm
	TT Optima 50 Perfotherm®				
80	TT Optima 50 FB	2025 mm	812 mm	2076 mm	896 mm
	TT Optima 50 Perfotherm®			2087 mm	918 mm
	TT Optima 60 Perfotherm®				
	TT OPTIMA 60 Alutherm®				
90E	TT Optima 50 FB	2025 mm	925 mm	2076 mm	1009 mm
	TT Optima 50 Perfotherm®			2087 mm	1031 mm
	TT Optima 60 Perfotherm®				
	TT OPTIMA 60 Alutherm®				
100E	TT Optima 50 FB	2025 mm	1025 mm	2076 mm	1109 mm
	TT Optima 50 Perfotherm®			2087 mm	1131 mm
	TT Optima 60 Perfotherm®				
	TT OPTIMA 60 Alutherm®				

\*Includes an installation clearance of 10 mm

## CHOOSE THE AVAILABLE WIDTHS AND DECIDE → p. 76-77

4.



## ENJOY THE ABILITY TO CUSTOMISE BY CHOOSING THE VENEER DESIGN AND DETAIL PATTERN

DOORS NTT REVO DESIGNS → p. 12-13  
 DOORS TT OPTIMA DESIGNS → p. 18-19

5.



## CHOOSE OPTIONAL ADDITIONAL ACCESSORIES: FANLIGHTS, HANDLES, PULLS, FRAMES

→ p. 69-77

# DOOR CONSTRUCTION

## NTT REVO 75

Doors for use in single- and multi-family developments.

### PARAMETERS

- a 75-mm thick steel door leaf with a four-sided rabbet, filled with graphite-modified expanded polystyrene, comprising:
  - a DUOTHERM steel frame with a wooden core and an ALU/ PVC warm threshold and sill,
  - an ALUTHERM aluminium frame and an ALU/ PVC warm threshold and sill – available for an additional fee;
- available in solid and glazed versions, in 80, 90E and 100E sizes; size 100E available for an additional fee;
- RC2-class (solid) and RC2N-class (glazed) doors available;
- optionally and for an additional fee, an RC3-class version of the door is available (solid doors only) – GERDA NTT 75/RC3;
- doors available in four designs: AIR GLASS, QUADRO, ELITE 3D, TEMPO;
- doors available in 10 colours;
- door leaves available in a two-colour version for an additional fee;
- DUOTHERM door frames only available in single colour;
- ALUTHERM door frames available in two-colour versions for no additional fees;
- dedicated sets of trims available with the doors (leaves are ready for the installation of the chosen set).



### DUOTHERM

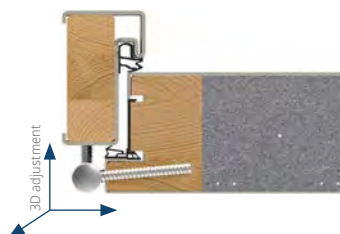

### optional ALUTHERM

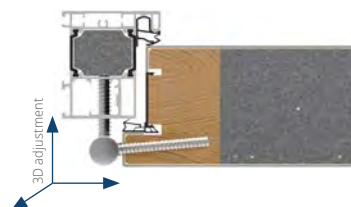



# NTT REVO 75

External burglar-proof  
RC2/RC3-class\* entry doors

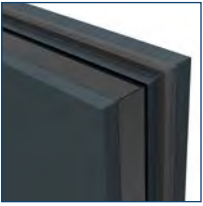

**Thermal compartment**  
inside the leaf



**Leaf**  
with a three-layer stile  
and a two-component seal

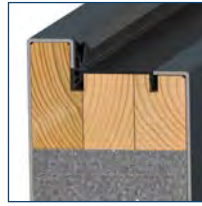

**Insulating filling**  
graphite-modified  
expanded polystyrene

**Ud 0,77** w/m<sup>2</sup>K

DOOR HEAT PENETRATION  
RATIO



**ALUTHERM**  
**Warm aluminium frame**  
with a thermal chamber  
filling and seal

**Ud 0,94** w/m<sup>2</sup>K

DOOR HEAT PENETRATION  
RATIO



**DUOTHERM**  
**Warm steel and wood frame**  
with thermal perforation  
and a seal



**Upper lock**  
class 6 3-tumbler  
GERDA ZW 500



**Central lock**  
class 7 3-tumbler  
GERDA ZW 2000



**Handles or pull**  
with inlays



**Lower lock**  
2-tumbler

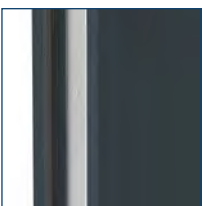

**Reinforcing strip**  
made of stainless steel,  
on the edge of the leaf



**3D hinges**  
adjustable in three  
dimensions



**Decorative cap**  
made of anodised  
aluminium in the same  
colour as the handle



**Adjustable lock  
mounting**



**3 interlocking pins**



**Lower rabbet**  
inside the leaf



**Warm PVC threshold**  
with a PVC sill and  
a windstopper



**Warm ALU/PVC threshold**  
with a thermal compartment,  
PVC sill and windstopper



**Installation kit**

\* RC3 package optionally available for an extra fee and glazed doors

— standard equipment  
- - - optional equipment, available for an extra fee

# DOOR CONSTRUCTION

## NTT REVO 60

Doors for use in single- and multi-family developments.

### PARAMETERS

- a 61-mm thick steel door leaf with a four-sided rabbet, filled with graphite-modified expanded polystyrene, comprising:
  - a DUOTHERM steel frame with a wooden core and an ALU/ PVC warm threshold and sill,
  - an ALUTHERM aluminium frame and an ALU/ PVC warm threshold and sill – available for an additional fee;
- available in solid and glazed versions, in 80, 90E and 100E sizes; size 100E available for an additional fee;
- RC2-class (solid) and RC2N-class (glazed) doors available;
- optionally and for an additional fee, an RC3-class version of the door is available (solid doors only) – GERDA NTT 60/RC3;
- doors available in four designs: AIR GLASS, QUADRO, ELITE 3D, TEMPO;
- doors available in 10 colours;
- door leaves available in a two-colour version for an additional fee;
- DUOTHERM door frames only available in single colour;
- ALUTHERM door frames available in two-colour versions for no additional fees;
- dedicated sets of trims available with the doors (leaves are ready for the installation of the chosen set).



### DUOTHERM

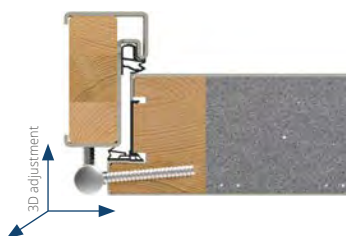

### optional ALUTHERM

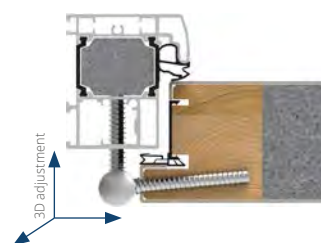

# NTT REVO 60

External burglar-proof  
RC2/RC3-class\* entry doors



**Thermal compartment**  
inside the leaf



**Leaf**  
with a three-layer stile  
and a two-component seal



**Insulating filling**  
graphite-modified  
expanded polystyrene

**Ud 0,87 w/m²K**

DOOR HEAT PENETRATION  
RATIO

**ALUTHERM**



**Warm aluminium frame**  
with a thermal chamber  
filling and seal

**Ud 1,0 w/m²K**

DOOR HEAT PENETRATION  
RATIO

**DUOTHERM**



**Warm steel and wood frame**  
with thermal perforation  
and a seal



**Upper lock**  
class 6 3-tumbler  
GERDA ZW 500



**Main lock**  
class-7 3-tumbler  
GERDA ZW 1000



**Handles or pull**  
with inlays



**3D hinges**  
adjustable in three  
dimensions



**Decorative cap**  
made of anodised  
aluminium in the same  
colour as the handle



**Adjustable lock  
mounting**

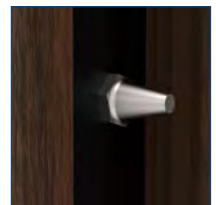

**3 interlocking pins**



**Lower rabbet**  
inside the leaf



**Warm PVC threshold**  
with a PVC sill and  
a windstopper



**Warm ALU/PVC threshold**  
with a thermal compartment,  
PVC sill and windstopper



**Installation kit**

\* RC3 package optionally available for an extra fee and glazed doors

— standard equipment  
- - - optional equipment, available for an extra fee

# NTT REVO DOOR DESIGNS\*

## AIR GLASS



AGB Linz 1 → p. 20



AGC Linz 2 → p. 20



AGD Linz 3 → p. 21



AGE Graz 1 → p. 22



AGF Graz 2 → p. 22

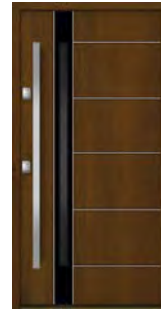

AGG Graz 3 → p. 23



AGA Salzburg → p. 24

## QUADRO



KWA Pasawa 1 → p. 26



KWB Pasawa 2 → p. 26



KWC Pasawa 3 → p. 26



KWD Pasawa 4 → p. 26



KWE Jena 1 → p. 27



KW2 Jena 2 → p. 27



KWF Bamberg 1 → p. 28



KWN Trewir 3 → p. 30



KWP Trewir 4 → p. 30



KWR Trewir 5 → p. 31



KW6 Trewir 6 → p. 31



KW7 Trewir 7 → p. 31



KWS Dorfen → p. 32



KWT Kassel 1 → p. 33



KPL Regen 3 → p. 35



KPS Regen 4 → p. 35



KPM Regen 5 → p. 35



KPR Regen 6 → p. 35



KPE Drezno 1 → p. 36



KPF Drezno 2 → p. 36

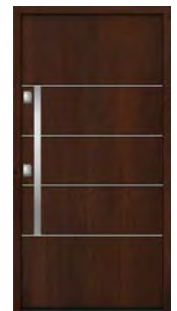

KPG Drezno 3 → p. 36

## ELITE 3D



ELA Brig → p. 38



ELB Olten → p. 38



ELC Visp → p. 39



ELD Trin → p. 39



ELE Berno → p. 40

## TEMPO



NS1 Milano 8 → p. 41



NS2 Milano 9 → p. 41



AGH Villach → p. 25



KWG Bamberg 2 → p. 28



KWH Bamberg 3 → p. 28



KWI Bamberg 4 → p. 28



KWJ Ulm 1 → p. 29



KWK Ulm 2 → p. 29



KWL Trewir 1 → p. 30



KWM Trewir 2 → p. 30



KWX Kassel 2 → p. 33



KPN Kronach 11 → p. 34



KPP Kronach 2 → p. 34



KPT Kronach 3 → p. 34



KPZ Kronach 4 → p. 34



KPJ Regen 1 → p. 35



KPK Regen 2 → p. 35



KPH Drezno 4 → p. 36



KPI Drezno 5 → p. 36



KPA Erfurt 1 → p. 37



KPB Erfurt 2 → p. 37



KPC Erfurt 3 → p. 37



KPD Erfurt 4 → p. 37



W00 Flat surface → p. 45



NS9 Milano 12 → p. 41



NS3 Milano 10 → p. 42



NS4 Milano 11 → p. 42



NS5 Hanover 5 → p. 43



NS6 Hanover 6 → p. 43



NS7 Innsbruck → p. 44



NS8 Patra → p. 44

\* external side shown only, except for the TEMPO range

# DOOR CONSTRUCTION

## TT OPTIMA 60

Doors for use in single- and multi-family developments.

### PARAMETERS

- a 61-mm thick steel door leaf with a three-sided rabbet, filled with graphite-modified expanded polystyrene, available with:
  - a PERFOTHERM® steel frame and threshold,
  - an ALUTHERM OPTIMA aluminium frame and threshold – available for an additional fee;
- available in solid and glazed versions, in 80, 90E and 100E sizes; size 100E available for an additional fee;
- RC2-class (solid) and RC2N-class (glazed) doors available; to maintain class RC2, an escutcheon must be used with a main lock inlay protection;
- optionally and for an additional fee, an RC3-class version of the door is available (solid doors only) – GERDA TT OPTIMA 60/RC3;
- doors available in two designs: TEMPO and CLASSIC;
- doors available in 10 colours;
- door leaves available in a two-colour version for an additional fee;
- PERFOTHERM® door frames only available in single colour;
- ALUTHERM OPTIMA door frames available in two-colour versions for no additional fees;
- dedicated sets of trims available with the doors (leaves are ready for the installation of the chosen set);
- available in a dual-leaf version as TT OPTIMA DUO 60.

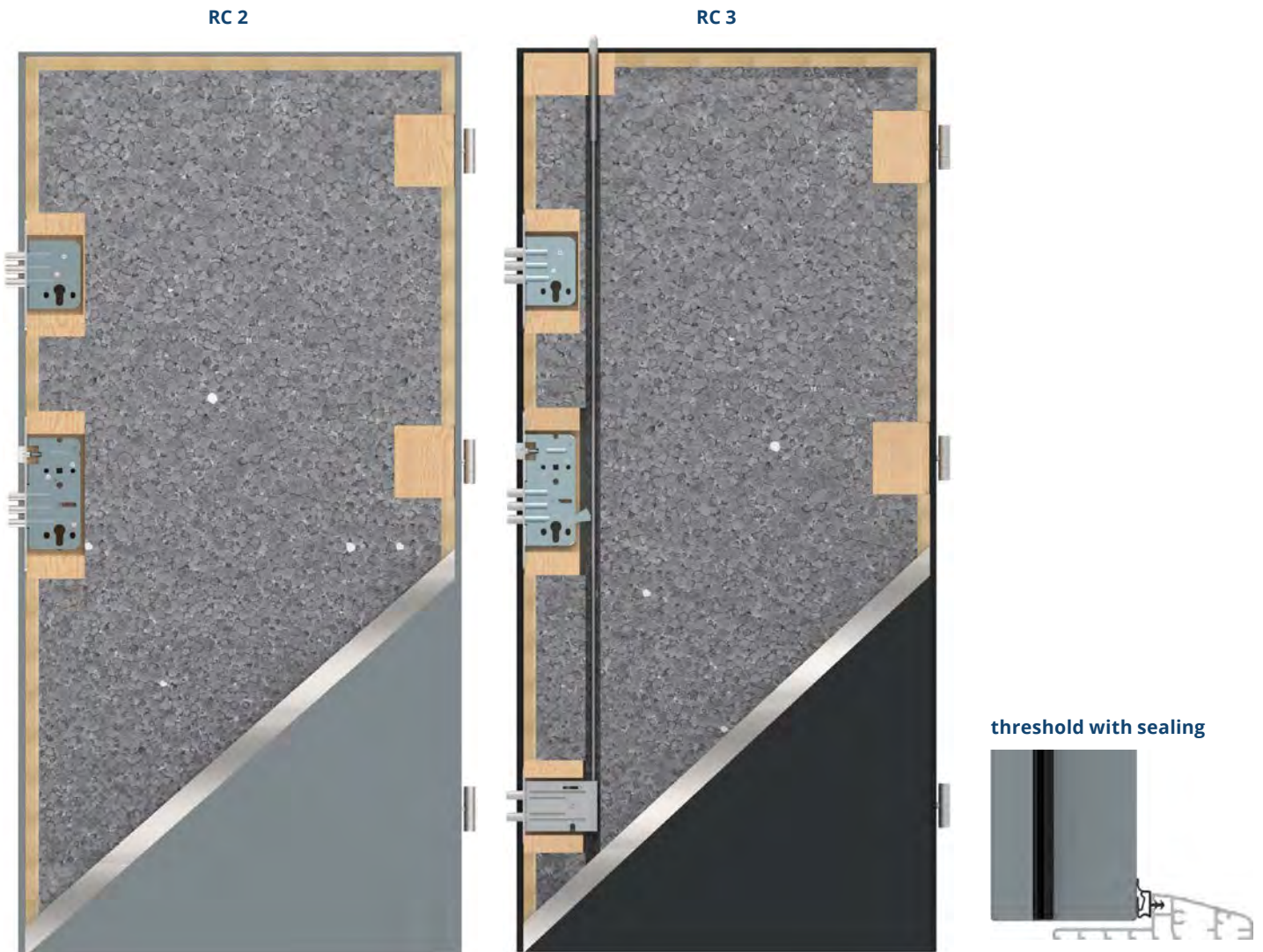

### PERFOTHERM®

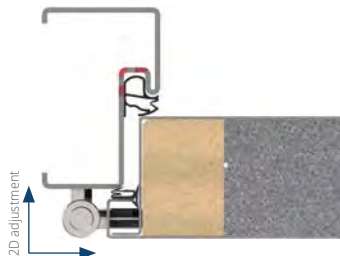

### optional ALUTHERM OPTIMA



# TT OPTIMA 60

External burglar-proof  
RC2/RC3-class\* entry doors

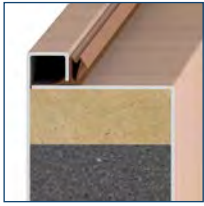

**Leaf cross-section**



**Leaf**  
with a three-layer stile  
and a two-component seal



**Upper lock**  
class 6 3-tumbler  
GERDA ZW 500



**Main lock**  
class 7 3-tumbler  
GERDA ZW 1000

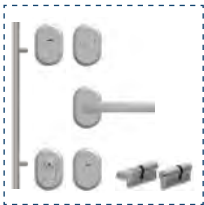

**Handles, handle/  
knob or pull**  
with inlays



**Ud 0,99 w/m<sup>2</sup>K**

DOOR HEAT PENETRATION  
RATIO

**ALUTHERM**



**Warm aluminium  
frame**  
with a thermal chamber  
filling and seal

**Ud 1,09 w/m<sup>2</sup>K**

DOOR HEAT PENETRATION  
RATIO

**PERFOTHERM®**



**Steel frame**  
with thermal  
perforation and seal



**2D hinges**  
adjustable



**Decorative caps**  
made of anodised  
aluminium in the same  
colour as the handle

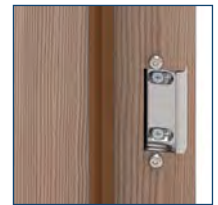

**Adjustable lock  
mounting**

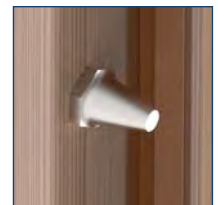

**3 interlocking pins**



**Aluminium threshold**  
with a seal



**Sill extension**



**Wooden threshold**



**Installation kit**

\* RC2 package using an escutcheon, RC3 package with a ZW 2000 lock available as an option for an additional charge, not applicable to glazed doors

— standard equipment  
- - - optional equipment, available for an extra fee

# DOOR CONSTRUCTION

## TT OPTIMA 50

Doors for use in single- and multi-family developments.

### PARAMETERS

- 51-mm thick steel leaves with a three-sided rabbet, filled with graphite-modified expanded polystyrene, comprising:
  - an FN or FB steel frame and threshold,
  - a PERFOTHERM® frame and threshold – available for an additional fee;
- when used as an entry door, we recommend using a PERFOTHERM® frame;
- available in solid versions, in 80, 90E and 100E sizes; size 100E available for an additional fee;
- RC2-class doors; to maintain class RC2, an escutcheon must be used with a main lock inlay protection;
- doors available in two designs: TEMPO and CLASSIC without glazing;
- doors available in 10 colours;
- door leaves available in a two-colour version for an additional fee;
- frames available only in a single colour;
- dedicated sets of trims available with the doors (leaves are ready for the installation of the chosen set).



threshold with sealing



STEEL FB



STEEL FN

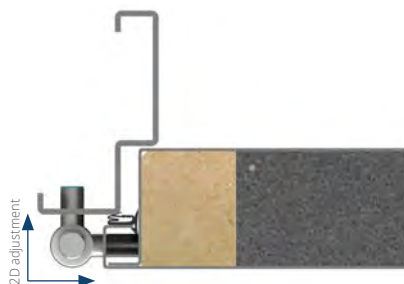

optionally **PERFOTHERM®**

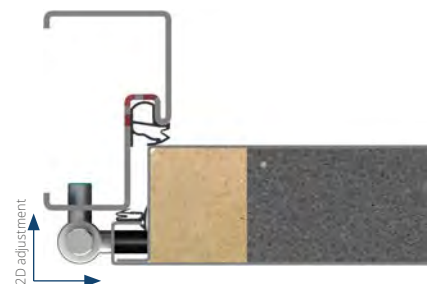



# TT OPTIMA 50

External burglar-proof  
RC2-class doors\*

**Ud 1,2 w/m<sup>2</sup>K**

DOOR HEAT PENETRATION  
RATIO

**PERFOTHERM®**



**Steel frame**  
with thermal  
perforation and seal



**Leaf cross-section**



**Leaf**  
with a stile strip  
and a two-component seal

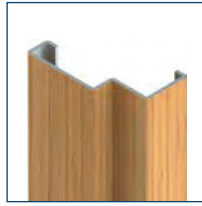

**FN frame**



**FB frame**



**Upper lock**  
class 6 3-tumbler  
GERDA ZW 500



**Main lock**  
class 7 3-tumbler  
GERDA ZW 1000

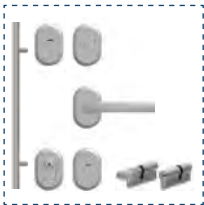

**Handles, handle/  
knob or pull**  
with inlays



**2D hinges**  
adjustable



**Decorative caps**  
made of anodised  
aluminium in the same  
colour as the handle



**Adjustable lock  
mounting**

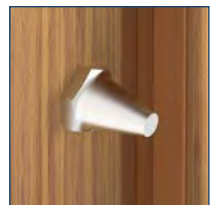

**3 interlocking pins**



**Aluminium threshold**  
with a seal

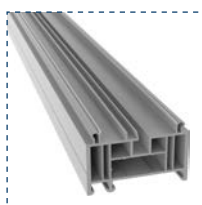

**Sill extension**



**Wooden threshold**



**Installation kit**

\* RC2 package using an escutcheon with lock cylinder protection

— standard equipment  
- - - optional equipment, available for an extra fee

# TT OPTIMADOOR DESIGNS\*

## TEMPO



NS1 Milano 8 → p. 41



NS2 Milano 9 → p. 41



NS9 Milano 12 → p. 41

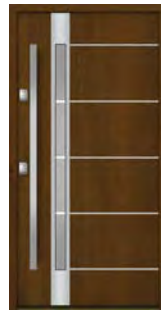

NS3 Milano 10 → p. 42



NS4 Milano 11 → p. 42



NS5 Hanover 5 → p. 43



NS6 Hanover 6 → p. 43



ST7 Oslo → p. 48



NT3 Turyn 3 → p. 49



NT2 Turyn 2 → p. 49



NT1 Turyn 1 → p. 49



SOJ Bergamo 2 → p. 50



SOK Bergamo 3 → p. 50



SJ8 Nicea 8 → p. 51



TMMA Tokio 2A → p. 56



ST8 Ryga → p. 57



ST9 Lund → p. 57



TN7 Aspen 2 → p. 58



W00 Flat surface → p. 45



ST4 Uppsala 1 → p. 54



ST5 Uppsala 2 → p. 55

## CLASSIC



W6A Modena → p. 60



W77 Modena 2 → p. 60



W78 Modena 3 → p. 60



WDR Ravenna → p. 60



WJ1 Nicea 5 → p. 60



W23 Olympia → p. 61



W29 Kolonia → p. 61



W6A Verona 4 → p. 62

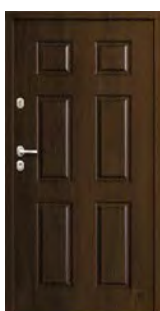

W24 Lizbona → p. 63

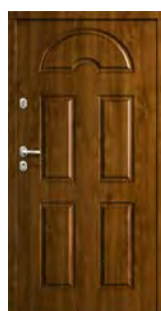

W9N Wencja → p. 63



W5L Londyn 1 → p. 64



W13 Londyn → p. 64



W53 Barcelona 1 → p. 65



W54 Barcelona → p. 65



NS7 Innsbruck → p. 44



NS8 Patra → p. 44



SNUA Milano 4A → p. 46



SNU Milano 4 → p. 46



SR1 Milano 14 → p. 47



SR2 Milano 15 → p. 47



ST6 Narvik → p. 48



SJ9 Nicea 9 → p. 51



SJ7 Nicea 7 → p. 51



SCF Patra 5 → p. 52



SBE Berlin 4 → p. 53



ST4A Uppsala 1A → p. 54



ST5A Uppsala 2A → p. 55



TMLA Tokio 1A → p. 56



TML Tokio 1 → p. 56



TMM Tokio 2 → p. 56



WBA Aspen 1 → p. 58



SR3 Tromso → p. 59



SR4 Tromso 1 → p. 59



SR5 Tromso 2 → p. 59



WQA Verona 5 → p. 62



W91 Verona → p. 62



W94 Verona 1 → p. 62



W93 Verona 3 → p. 62



G75 Genewa 2 → p. 66



D75 Genewa 3 → p. 66



G76 Genewa 1 → p. 66



\* external and internal side shown



Bergen handles with B-A inlays (RC2)

Bergen handles with single-key MB-B inlays (RC2)

Bergen handles with single-key MC-C inlays (RC2)

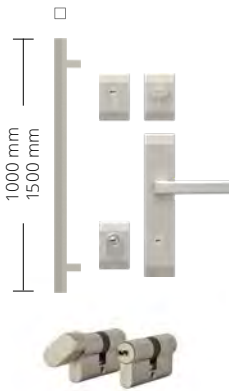

Amsterdam 1000 with B-A inlays (RC2)

Amsterdam 1000 with single-key MB-B inlays (RC2)

Amsterdam 1000 with single-key MC-C inlays (RC2)

Amsterdam 1500 with B-A inlays (RC2)

Amsterdam 1500 with single-key MB-B inlays (RC2)

Amsterdam 1500 with single-key MC-C inlays (RC2)



**AGB Linz 1**



**AGC Linz 2**

### DOOR SIZES

**NTT 60** 80 | 90 E | 100 E  
**NTT 75** 80 | 90 E | 100 E

### GLAZING

GRAPHITE



MODEL	NTT 60	NTT 75
AGB Linz 1	✓	✓
AGC Linz 2	✓	✓

AVAILABLE FOR AN ADDITIONAL FEE	NTT 60	NTT 75
ALUTHERM frame	✓	✓
size 100 E	✓	✓

Fixed aluminium fanlights on page 70  
 Full list of available accessories on pages 74-75



Internal side of the door



### COLOURS

WHITE FSB	GOLDEN OAK FDE	MAHOGANY FMA	ANTHRACITE FKG	DARK ANTHRACITE FKF
LIGHT CHESTNUT FRP	ALPINE CHESTNUT FRR	BRAZILIAN CHESTNUT FRB	WINCHESTER FDW	GREY STEEL FKZ



AGD

Linz 3

### DOOR SIZES

**NTT 60** 80 | 90 E | 100 E  
**NTT 75** 80 | 90 E | 100 E

### GLAZING

GRAPHITE



MODEL	NTT 60	NTT 75
AGD Linz 3	✓	✓

AVAILABLE FOR AN ADDITIONAL FEE	NTT 60	NTT 75
ALUTHERM frame	✓	✓
size 100 E	✓	✓

Fixed aluminium fanlights on page 70  
 Full list of available accessories on pages 74-75



Internal side of the door



Bergen handles with B-A inlays (RC2)

Bergen handles with single-key MB-B inlays (RC2)

Bergen handles with single-key MC-C inlays (RC2)

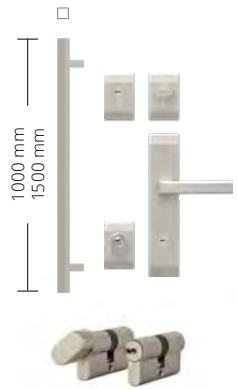

Amsterdam 1000 with B-A inlays (RC2)

Amsterdam 1000 with single-key MB-B inlays (RC2)

Amsterdam 1000 with single-key MC-C inlays (RC2)

Amsterdam 1500 with B-A inlays (RC2)

Amsterdam 1500 with single-key MB-B inlays (RC2)

Amsterdam 1500 with single-key MC-C inlays (RC2)

### COLOURS

WHITE FSB	GOLDEN OAK FDE	MAHOGANY FMA	ANTHRACITE FKG	DARK ANTHRACITE FKF
LIGHT CHESTNUT FRP	ALPINE CHESTNUT FRR	BRAZILIAN CHESTNUT FRB	WINCHESTER FDW	GREY STEEL FKZ





Bergen handles with B-A inlays (RC2)

Bergen handles with single-key MB-B inlays (RC2)

Bergen handles with single-key MC-C inlays (RC2)

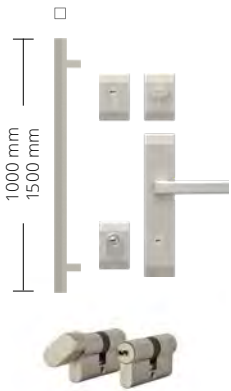

Amsterdam 1000 with B-A inlays (RC2)

Amsterdam 1000 with single-key MB-B inlays (RC2)

Amsterdam 1000 with single-key MC-C inlays (RC2)

Amsterdam 1500 with B-A inlays (RC2)

Amsterdam 1500 with single-key MB-B inlays (RC2)

Amsterdam 1500 with single-key MC-C inlays (RC2)



**AGE** **Graz 1**



**AGF** **Graz 2**

### DOOR SIZES

**NTT 60** 80 | 90 E | 100 E  
**NTT 75** 80 | 90 E | 100 E

### GLAZING

GRAPHITE



MODEL	NTT 60	NTT 75
AGE Graz 1	✓	✓
AGF Graz 2	✓	✓

AVAILABLE FOR AN ADDITIONAL FEE	NTT 60	NTT 75
ALUTHERM frame	✓	✓
size 100 E	✓	✓

Fixed aluminium fanlights on page 70  
 Full list of available accessories on pages 74-75



Internal side of the door



### COLOURS

WHITE FSB	GOLDEN OAK FDE	MAHOGANY FMA	ANTHRACITE FKG	DARK ANTHRACITE FKF
LIGHT CHESTNUT FRP	ALPINE CHESTNUT FRR	BRAZILIAN CHESTNUT FRB	WINCHESTER FDW	GREY STEEL FKZ



AGG

Graz 3

### DOOR SIZES

NTT 60 80 | 90 E | 100 E  
 NTT 75 80 | 90 E | 100 E

### GLAZING

GRAPHITE



MODEL	NTT 60	NTT 75
AGG Graz 3	✓	✓

AVAILABLE FOR AN ADDITIONAL FEE	NTT 60	NTT 75
ALUTHERM frame	✓	✓
size 100 E	✓	✓

Fixed aluminium fanlights on page 70  
 Full list of available accessories on pages 74-75



Internal side of the door



Bergen handles with B-A inlays (RC2)

Bergen handles with single-key MB-B inlays (RC2)

Bergen handles with single-key MC-C inlays (RC2)



Amsterdam 1000 with B-A inlays (RC2)

Amsterdam 1000 with single-key MB-B inlays (RC2)

Amsterdam 1000 with single-key MC-C inlays (RC2)

Amsterdam 1500 with B-A inlays (RC2)

Amsterdam 1500 with single-key MB-B inlays (RC2)

Amsterdam 1500 with single-key MC-C inlays (RC2)

### COLOURS

WHITE FSB	GOLDEN OAK FDE	MAHOGANY FMA	ANTHRACITE FKG	DARK ANTHRACITE FKF
LIGHT CHESTNUT FRP	ALPINE CHESTNUT FRR	BRAZILIAN CHESTNUT FRB	WINCHESTER FDW	GREY STEEL FKZ





Bergen handles with B-A inlays (RC2)

Bergen handles with single-key MB-B inlays (RC2)

Bergen handles with single-key MC-C inlays (RC2)

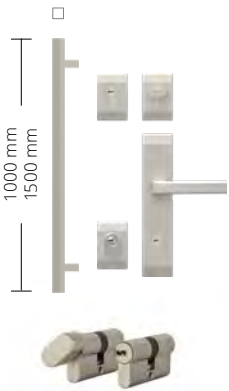

Amsterdam 1000 with B-A inlays (RC2)

Amsterdam 1000 with single-key MB-B inlays (RC2)

Amsterdam 1000 with single-key MC-C inlays (RC2)

Amsterdam 1500 with B-A inlays (RC2)

Amsterdam 1500 with single-key MB-B inlays (RC2)

Amsterdam 1500 with single-key MC-C inlays (RC2)



AGA Salzburg

## DOOR SIZES

**NTT 60** 80 | 90 E | 100 E  
**NTT 75** 80 | 90 E | 100 E

## GLAZING

GRAPHITE



MODEL	NTT 60	NTT 75
AGA Salzburg	✓	✓

AVAILABLE FOR AN ADDITIONAL FEE	NTT 60	NTT 75
ALUTHERM frame	✓	✓
size 100 E	✓	✓

Fixed aluminium fanlights on page 70  
 Full list of available accessories on pages 74-75



Internal side of the door



## COLOURS

WHITE FSB	GOLDEN OAK FDE	MAHOGANY FMA	ANTHRACITE FKG	DARK ANTHRACITE FKF
LIGHT CHESTNUT FRP	ALPINE CHESTNUT FRR	BRAZILIAN CHESTNUT FRB	WINCHESTER FDW	GREY STEEL FKZ







**AGH Villach**

### DOOR SIZES

**NTT 60** 90 E | 100 E  
**NTT 75** 90 E | 100 E

### GLAZING

GRAPHITE



MODEL	NTT 60	NTT 75
AGH Villach	✓	✓

AVAILABLE FOR AN ADDITIONAL FEE	NTT 60	NTT 75
ALUTHERM frame	✓	✓
size 100 E	✓	✓

Fixed aluminium fanlights on page 70  
 Full list of available accessories on pages 74-75



Internal side of the door



Bergen handles with B-A inlays (RC2)

Bergen handles with single-key MB-B inlays (RC2)

Bergen handles with single-key MC-C inlays (RC2)

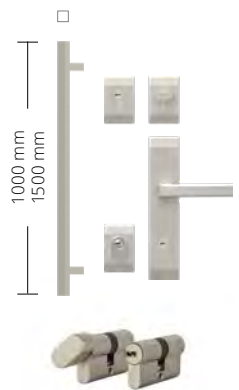

Amsterdam 1000 with B-A inlays (RC2)

Amsterdam 1000 with single-key MB-B inlays (RC2)

Amsterdam 1000 with single-key MC-C inlays (RC2)

Amsterdam 1500 with B-A inlays (RC2)

Amsterdam 1500 with single-key MB-B inlays (RC2)

Amsterdam 1500 with single-key MC-C inlays (RC2)

### COLOURS

WHITE FSB	GOLDEN OAK FDE	MAHOGANY FMA	ANTHRACITE FKG	DARK ANTHRACITE FKF
LIGHT CHESTNUT FRP	ALPINE CHESTNUT FRR	BRAZILIAN CHESTNUT FRB	WINCHESTER FDW	GREY STEEL FKZ





Bergen handles with B-A inlays (RC2)

Bergen handles with single-key MB-B inlays (RC2)

Bergen handles with single-key MC-C inlays (RC2)

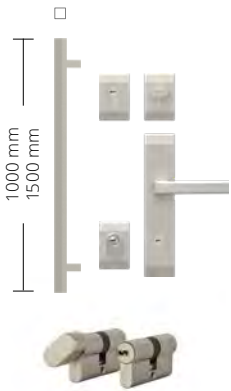

Amsterdam 1000 with B-A inlays (RC2)

Amsterdam 1000 with single-key MB-B inlays (RC2)

Amsterdam 1000 with single-key MC-C inlays (RC2)

Amsterdam 1500 with B-A inlays (RC2)

Amsterdam 1500 with single-key MB-B inlays (RC2)

Amsterdam 1500 with single-key MC-C inlays (RC2)



**KWA Pasawa 1**



**KWB Pasawa 2**



**KWC Pasawa 3**



**KWD Pasawa 4**

## DOOR SIZES

**NTT 60** 80 | 90 E | 100 E  
**NTT 75** 80 | 90 E | 100 E

## GLAZING

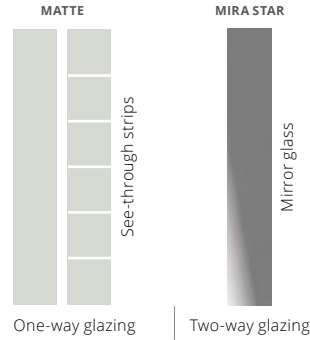

MODEL	NTT 60	NTT 75
KWA Pasawa 1	✓	✓
KWB Pasawa 2	✓	✓
KWC Pasawa 3	✓	✓
KWD Pasawa 4	✓	✓

AVAILABLE FOR AN ADDITIONAL FEE	NTT 60	NTT 75
ALUTHERM frame	✓	✓
size 100 E	✓	✓
shortening 0-40 mm KWA; KWB; KWC 0-100 mm KWD	✓	✓

Fixed aluminium fanlights on page 70  
 Full list of available accessories on pages 74-75

Internal side of the door



## COLOURS

WHITE FSB	GOLDEN OAK FDE	MAHOGANY FMA	ANTHRACITE FKG	DARK ANTHRACITE FKF
LIGHT CHESTNUT FRP	ALPINE CHESTNUT FRR	BRAZILIAN CHESTNUT FRB	WINCHESTER FDW	GREY STEEL FKZ



**KWE** Jena 1

### DOOR SIZES

**NTT 60** 80 | 90 E | 100 E  
**NTT 75** 80 | 90 E | 100 E

### GLAZING

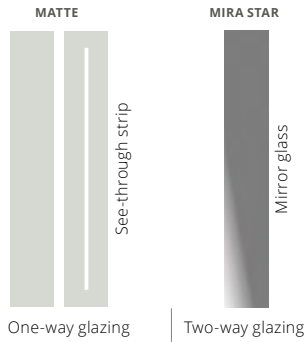

MODEL	NTT 60	NTT 75
KWE Jena 1	✓	✓
KW2 Jena 2	✓	✓

AVAILABLE FOR AN ADDITIONAL FEE	NTT 60	NTT 75
ALUTHERM frame	✓	✓
size 100 E	✓	✓
shortening 0-40 mm	✓	✓

Fixed aluminium fanlights on page 70  
 Full list of available accessories on pages 74-75



**KW2** Jena 2

### DOOR SIZES

**NTT 60** 80 | 90 E | 100 E  
**NTT 75** 80 | 90 E | 100 E

### GLAZING

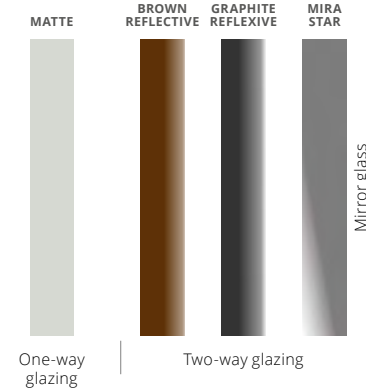

Internal side of the door



Bergen handles with B-A inlays (RC2)

Bergen handles with single-key MB-B inlays (RC2)

Bergen handles with single-key MC-C inlays (RC2)

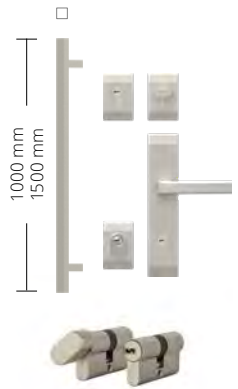

Amsterdam 1000 with B-A inlays (RC2)

Amsterdam 1000 with single-key MB-B inlays (RC2)

Amsterdam 1000 with single-key MC-C inlays (RC2)

Amsterdam 1500 with B-A inlays (RC2)

Amsterdam 1500 with single-key MB-B inlays (RC2)

Amsterdam 1500 with single-key MC-C inlays (RC2)

### COLOURS

WHITE FSB	GOLDEN OAK FDE	MAHOGANY FMA	ANTHRACITE FKG	DARK ANTHRACITE FKF
LIGHT CHESTNUT FRP	ALPINE CHESTNUT FRR	BRAZILIAN CHESTNUT FRB	WINCHESTER FDW	GREY STEEL FKZ





Bergen handles with B-A inlays (RC2)

Bergen handles with single-key MB-B inlays (RC2)

Bergen handles with single-key MC-C inlays (RC2)

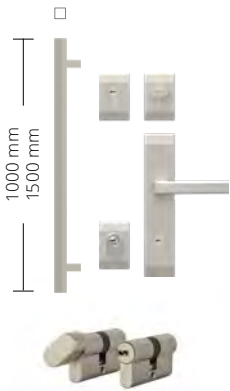

Amsterdam 1000 with B-A inlays (RC2)

Amsterdam 1000 with single-key MB-B inlays (RC2)

Amsterdam 1000 with single-key MC-C inlays (RC2)

Amsterdam 1500 with B-A inlays (RC2)

Amsterdam 1500 with single-key MB-B inlays (RC2)

Amsterdam 1500 with single-key MC-C inlays (RC2)



**KWF Bamberg 1**



**KWG Bamberg 2**



**KWH Bamberg 3**



**KWI Bamberg 4**

## DOOR SIZES

**NTT 60** 80 | 90 E | 100 E  
**NTT 75** 80 | 90 E | 100 E

## GLAZING

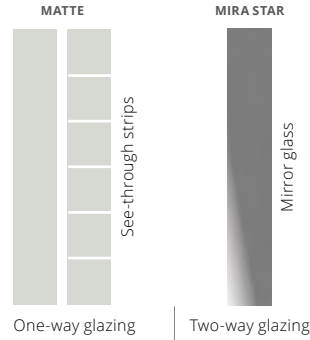

MODEL	NTT 60	NTT 75
KWF Bamberg 1	✓	✓
KWG Bamberg 2	✓	✓
KWH Bamberg 3	✓	✓
KWI Bamberg 4	✓	✓

AVAILABLE FOR AN ADDITIONAL FEE	NTT 60	NTT 75
ALUTHERM frame	✓	✓
size 100 E	✓	✓
shortening 0-40 mm	✓	✓

Fixed aluminium fanlights on page 70  
 Full list of available accessories on pages 74-75



Internal side of the door



## COLOURS

WHITE FSB	GOLDEN OAK FDE	MAHOGANY FMA	ANTHRACITE FKG	DARK ANTHRACITE FKF
LIGHT CHESTNUT FRP	ALPINE CHESTNUT FRR	BRAZILIAN CHESTNUT FRB	WINCHESTER FDW	GREY STEEL FKZ



KWJ

Ulm 1



KWK

Ulm 2

## DOOR SIZES

**NTT 60** 80 | 90 E | 100 E  
**NTT 75** 80 | 90 E | 100 E

## GLAZING

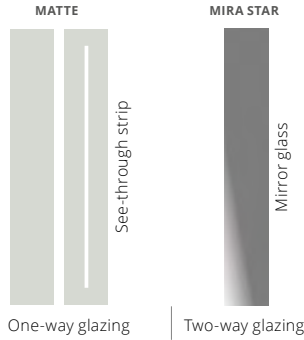

MODEL	NTT 60	NTT 75
KWJ Ulm 1	✓	✓
KWK Ulm 2	✓	✓

AVAILABLE FOR AN ADDITIONAL FEE	NTT 60	NTT 75
ALUTHERM frame	✓	✓
size 100 E	✓	✓
shortening 0-40 mm	✓	✓

Fixed aluminium fanlights on page 70  
 Full list of available accessories on pages 74-75

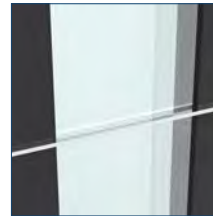

Internal side of the door



Bergen handles with B-A inlays (RC2)

Bergen handles with single-key MB-B inlays (RC2)

Bergen handles with single-key MC-C inlays (RC2)

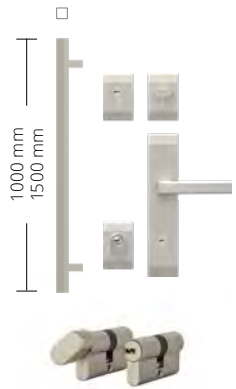

Amsterdam 1000 with B-A inlays (RC2)

Amsterdam 1000 with single-key MB-B inlays (RC2)

Amsterdam 1000 with single-key MC-C inlays (RC2)

Amsterdam 1500 with B-A inlays (RC2)

Amsterdam 1500 with single-key MB-B inlays (RC2)

Amsterdam 1500 with single-key MC-C inlays (RC2)

## COLOURS

WHITE FSB	GOLDEN OAK FDE	MAHOGANY FMA	ANTHRACITE FKG	DARK ANTHRACITE FKF
LIGHT CHESTNUT FRP	ALPINE CHESTNUT FRR	BRAZILIAN CHESTNUT FRB	WINCHESTER FDW	GREY STEEL FKZ





Bergen handles with B-A inlays (RC2)

Bergen handles with single-key MB-B inlays (RC2)

Bergen handles with single-key MC-C inlays (RC2)

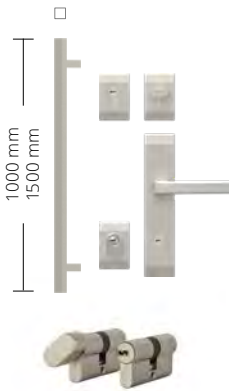

Amsterdam 1000 with B-A inlays (RC2)

Amsterdam 1000 with single-key MB-B inlays (RC2)

Amsterdam 1000 with single-key MC-C inlays (RC2)

Amsterdam 1500 with B-A inlays (RC2)

Amsterdam 1500 with single-key MB-B inlays (RC2)

Amsterdam 1500 with single-key MC-C inlays (RC2)



**KWL Trewir 1**



**KWM Trewir 2**



**KWN Trewir 3**



**KWP Trewir 4**

## DOOR SIZES

**NTT 60** 80 | 90 E | 100 E  
**NTT 75** 80 | 90 E | 100 E

## GLAZING



## MODEL

MODEL	NTT 60	NTT 75
KWL Trewir 1	✓	✓
KWM Trewir 2	✓	✓
KWN Trewir 3	✓	✓
KWP Trewir 4	✓	✓

## AVAILABLE FOR AN ADDITIONAL FEE

AVAILABLE FOR AN ADDITIONAL FEE	NTT 60	NTT 75
ALUTHERM frame	✓	✓
size 100 E	✓	✓
shortening 0-40 mm	✓	✓

Fixed aluminium fanlights on page 70  
 Full list of available accessories on pages 74-75



Internal side of the door



## COLOURS

WHITE FSB	GOLDEN OAK FDE	MAHOGANY FMA	ANTHRACITE FKG	DARK ANTHRACITE FKF
LIGHT CHESTNUT FRP	ALPINE CHESTNUT FRR	BRAZILIAN CHESTNUT FRB	WINCHESTER FDW	GREY STEEL FKZ



KWR

Trewir 5

### DOOR SIZES

**NTT 60** 80 | 90 E | 100 E  
**NTT 75** 80 | 90 E | 100 E

### GLAZING



MODEL	NTT 60	NTT 75
KWR Trewir 5	✓	✓
KW6 Trewir 6	✓	✓
KW7 Trewir 7	✓	✓

AVAILABLE FOR AN ADDITIONAL FEE	NTT 60	NTT 75
ALUTHERM frame	✓	✓
size 100 E	✓	✓
shortening 0-40 mm	✓	✓

Fixed aluminium fanlights on page 70  
 Full list of available accessories on pages 74-75



KW6

Trewir 6



KW7

Trewir 7



Internal side of the door



Bergen handles with B-A inlays (RC2)

Bergen handles with single-key MB-B inlays (RC2)

Bergen handles with single-key MC-C inlays (RC2)



Amsterdam 1000 with B-A inlays (RC2)

Amsterdam 1000 with single-key MB-B inlays (RC2)

Amsterdam 1000 with single-key MC-C inlays (RC2)

Amsterdam 1500 with B-A inlays (RC2)

Amsterdam 1500 with single-key MB-B inlays (RC2)

Amsterdam 1500 with single-key MC-C inlays (RC2)

### COLOURS

WHITE FSB	GOLDEN OAK FDE	MAHOGANY FMA	ANTHRACITE FKG	DARK ANTHRACITE FKF
LIGHT CHESTNUT FRP	ALPINE CHESTNUT FRR	BRAZILIAN CHESTNUT FRB	WINCHESTER FDW	GREY STEEL FKZ





Bergen handles with B-A inlays (RC2)

Bergen handles with single-key MB-B inlays (RC2)

Bergen handles with single-key MC-C inlays (RC2)

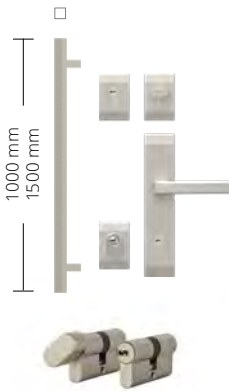

Amsterdam 1000 with B-A inlays (RC2)

Amsterdam 1000 with single-key MB-B inlays (RC2)

Amsterdam 1000 with single-key MC-C inlays (RC2)

Amsterdam 1500 with B-A inlays (RC2)

Amsterdam 1500 with single-key MB-B inlays (RC2)

Amsterdam 1500 with single-key MC-C inlays (RC2)



**KWS Dorfen**



**KWS Dorfen**

## DOOR SIZES

**NTT 60** 80 | 90 E | 100 E  
**NTT 75** 80 | 90 E | 100 E

## GLAZING

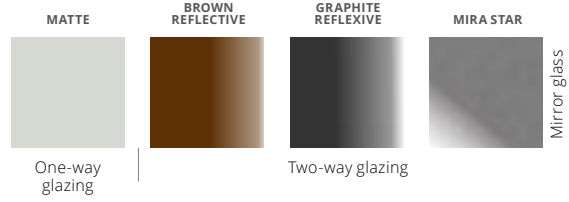

MODEL	NTT 60	NTT 75
KWS Dorfen	✓	✓

AVAILABLE FOR AN ADDITIONAL FEE	NTT 60	NTT 75
ALUTHERM frame	✓	✓
size 100 E	✓	✓
shortening 0-40 mm	✓	✓

Fixed aluminium fanlights on page 70  
 Full list of available accessories on pages 74-75



Internal side of the door



## COLOURS

WHITE FSB	GOLDEN OAK FDE	MAHOGANY FMA	ANTHRACITE FKG	DARK ANTHRACITE FKF
LIGHT CHESTNUT FRP	ALPINE CHESTNUT FRR	BRAZILIAN CHESTNUT FRB	WINCHESTER FDW	GREY STEEL FKZ





KWT

Kassel 1

### DOOR SIZES

NTT 60 80 | 90 E | 100 E  
 NTT 75 80 | 90 E | 100 E

### GLAZING

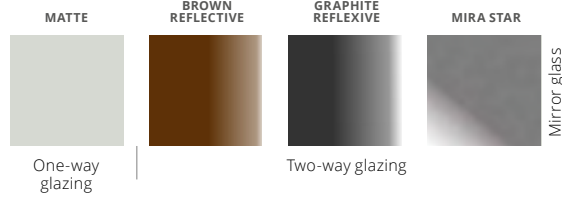

MODEL	NTT 60	NTT 75
KWT Kassel 1	✓	✓
KWX Kassel 2	✓	✓

AVAILABLE FOR AN ADDITIONAL FEE	NTT 60	NTT 75
ALUTHERM frame	✓	✓
size 100 E	✓	✓
shortening 0-40 mm	✓	✓

Fixed aluminium fanlights on page 70  
 Full list of available accessories on pages 74-75



KWT

Kassel 1



KWX

Kassel 2



Internal side of the door



Bergen handles with B-A inlays (RC2)

Bergen handles with single-key MB-B inlays (RC2)

Bergen handles with single-key MC-C inlays (RC2)

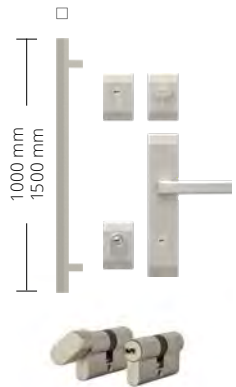

Amsterdam 1000 with B-A inlays (RC2)

Amsterdam 1000 with single-key MB-B inlays (RC2)

Amsterdam 1000 with single-key MC-C inlays (RC2)

Amsterdam 1500 with B-A inlays (RC2)

Amsterdam 1500 with single-key MB-B inlays (RC2)

Amsterdam 1500 with single-key MC-C inlays (RC2)

### COLOURS

WHITE FSB	GOLDEN OAK FDE	MAHOGANY FMA	ANTHRACITE FKG	DARK ANTHRACITE FKF
LIGHT CHESTNUT FRP	ALPINE CHESTNUT FRR	BRAZILIAN CHESTNUT FRB	WINCHESTER FDW	GREY STEEL FKZ





Bergen handles with B-A inlays (RC2/RC3)

Bergen handles with single-key MB-B inlays (RC2/RC3)

Bergen handles with single-key MC-C inlays (RC2/RC3)

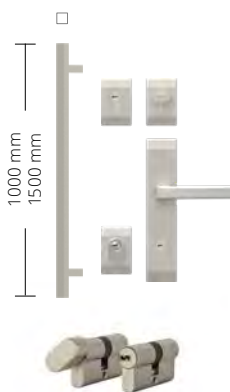

Amsterdam 1000 with B-A inlays (RC2/RC3)

Amsterdam 1000 with single-key MB-B inlays (RC2/RC3)

Amsterdam 1000 with single-key MC-C inlays (RC2/RC3)

Amsterdam 1500 with B-A inlays (RC2/RC3)

Amsterdam 1500 with single-key MB-B inlays (RC2/RC3)

Amsterdam 1500 with single-key MC-C inlays (RC2/RC3)



**KPN Kronach 1**



**KPT Kronach 3**



**KPP Kronach 2**



**KPZ Kronach 4**

## DOOR SIZES

**NTT 60** 80 | 90 E | 100 E

**NTT 75** 80 | 90 E | 100 E

MODEL	NTT 60	NTT 75
KPN Kronach 1 one-sided detail and insert	✓	✓
KPP Kronach 2 one-sided insert	✓	✓
KPT Kronach 3 one-sided detail and insert	✓	✓
KPZ Kronach 4 one-sided insert	✓	✓

AVAILABLE FOR AN ADDITIONAL FEE	NTT 60	NTT 75
ALUTHERM frame	✓	✓
size 100 E	✓	✓
insert and detail on the other side	✓	✓
insert on the other side	✓	✓
RC3 package	✓	✓
shortening 0-40 mm	✓	✓

Fixed aluminium fanlights on page 70

Full list of available accessories on pages 74-75



Internal side of the door



## COLOURS

WHITE FSB	GOLDEN OAK FDE	MAHOGANY FMA	ANTHRACITE FKG	DARK ANTHRACITE FKF
LIGHT CHESTNUT FRP	ALPINE CHESTNUT FRR	BRAZILIAN CHESTNUT FRB	WINCHESTER FDW	GREY STEEL FKZ

# NTT REVO QUADRO



**KPJ** Regen 1



**KPK** Regen 2



**KPL** Regen 3



**KPS** Regen 4



**KPM** Regen 5

## DOOR SIZES

**NTT 60** 80 | 90 E | 100 E  
**NTT 75** 80 | 90 E | 100 E

MODEL	NTT 60	NTT 75
KPJ Regen 1 one-sided detail and insert	✓	✓
KPK Regen 2 one-sided insert	✓	✓
KPL Regen 3 one-sided detail and insert	✓	✓
KPS Regen 4 one-sided insert	✓	✓
KPM Regen 5 one-sided detail and insert	✓	✓
KPR Regen 6 one-sided insert	✓	✓

AVAILABLE FOR AN ADDITIONAL FEE	NTT 60	NTT 75
ALUTHERM frame	✓	✓
size 100 E	✓	✓
insert and detail on the other side	✓	✓
insert on the other side	✓	✓
RC3 package	✓	✓
shortening 0-40 mm	✓	✓

Fixed aluminium fanlights on page 70  
 Full list of available accessories on pages 74-75



**KPR** Regen 6

Internal side of the door



## COLOURS

WHITE FSB	GOLDEN OAK FDE	MAHOGANY FMA	ANTHRACITE FKG	DARK ANTHRACITE FKF
LIGHT CHESTNUT FRP	ALPINE CHESTNUT FRR	BRAZILIAN CHESTNUT FRB	WINCHESTER FDW	GREY STEEL FKZ

# REGEN

PROPRIETARY DESIGN



Bergen handles with B-A inlays (RC2/RC3)

Bergen handles with single-key MB-B inlays (RC2/RC3)

Bergen handles with single-key MC-C inlays (RC2/RC3)

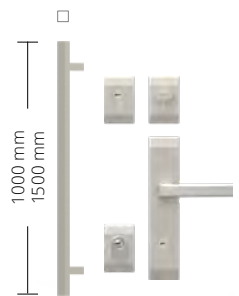

Amsterdam 1000 with B-A inlays (RC2/RC3)

Amsterdam 1000 with single-key MB-B inlays (RC2/RC3)

Amsterdam 1000 with single-key MC-C inlays (RC2/RC3)

Amsterdam 1500 with B-A inlays (RC2/RC3)

Amsterdam 1500 with single-key MB-B inlays (RC2/RC3)

Amsterdam 1500 with single-key MC-C inlays (RC2/RC3)





Bergen handles with B-A inlays (RC2/RC3)

Bergen handles with single-key MB-B inlays (RC2/RC3)

Bergen handles with single-key MC-C inlays (RC2/RC3)

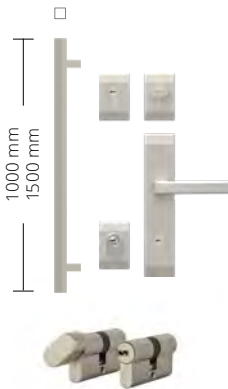

Amsterdam 1000 with B-A inlays (RC2/RC3)

Amsterdam 1000 with single-key MB-B inlays (RC2/RC3)

Amsterdam 1000 with single-key MC-C inlays (RC2/RC3)

Amsterdam 1500 with B-A inlays (RC2/RC3)

Amsterdam 1500 with single-key MB-B inlays (RC2/RC3)

Amsterdam 1500 with single-key MC-C inlays (RC2/RC3)

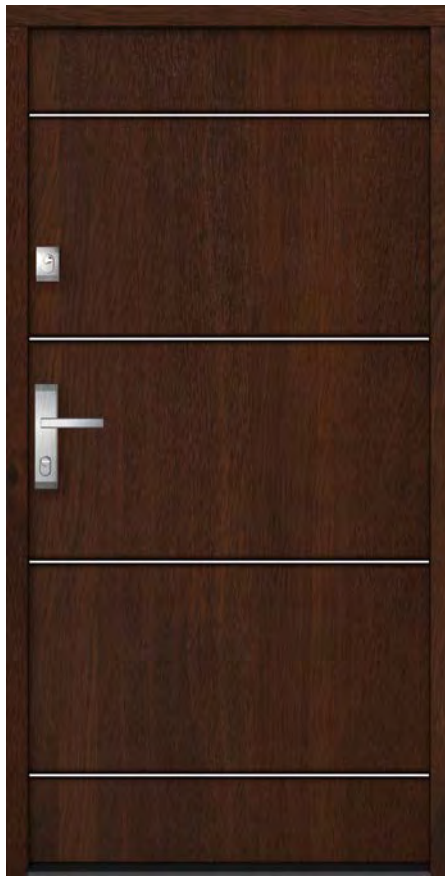

**KPE Drezno 1**



**KPF Drezno 2**

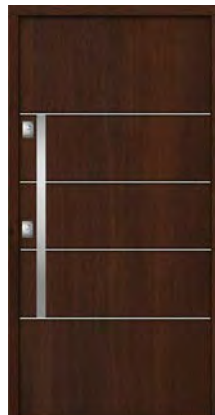

**KPG Drezno 3**



**KPH Drezno 4**



**KPI Drezno 5**

## DOOR SIZES

**NTT 60** 80 | 90 E | 100 E  
**NTT 75** 80 | 90 E | 100 E

MODEL	NTT 60	NTT 75
KPE Drezno 1 one-sided insert	✓	✓
KPF Drezno 2 one-sided insert	✓	✓
KPG Drezno 3 one-sided insert	✓	✓
KPH Drezno 4 one-sided insert	✓	✓
KPI Drezno 5 one-sided insert	✓	✓

AVAILABLE FOR AN ADDITIONAL FEE	NTT 60	NTT 75
ALUTHERM frame	✓	✓
size 100 E	✓	✓
insert on the other side	✓	✓
RC3 package	✓	✓
shortening 0-40 mm KPH 0-100 mm KPE; KPF; KPG	✓	✓

Fixed aluminium fanlights on page 70  
 Full list of available accessories on pages 74-75



Internal side of the door



## COLOURS

WHITE FSB	GOLDEN OAK FDE	MAHOGANY FMA	ANTHRACITE FKG	DARK ANTHRACITE FKF
LIGHT CHESTNUT FRP	ALPINE CHESTNUT FRR	BRAZILIAN CHESTNUT FRB	WINCHESTER FDW	GREY STEEL FKZ

# NTT REVO QUADRO



**KPA Erfurt 1**



**KPB Erfurt 2**



**KPC Erfurt 3**



**KPD Erfurt 4**

## DOOR SIZES

**NTT 60** 80 | 90 E | 100 E  
**NTT 75** 80 | 90 E | 100 E

MODEL	NTT 60	NTT 75
KPA Erfurt 1 one-sided insert	✓	✓
KPB Erfurt 2 one-sided insert	✓	✓
KPC Erfurt 3 one-sided insert	✓	✓
KPD Erfurt 4 one-sided insert	✓	✓

AVAILABLE FOR AN ADDITIONAL FEE	NTT 60	NTT 75
ALUTHERM frame	✓	✓
size 100 E	✓	✓
insert on the other side	✓	✓
RC3 package	✓	✓
shortening 0-40 mm KPH 0-100 mm KPE; KPF; KPG	✓	✓

Fixed aluminium fanlights on page 70  
 Full list of available accessories on pages 74-75



Internal side of the door



# ERFURT



Bergen handles with B-A inlays (RC2/RC3)

Bergen handles with single-key MB-B inlays (RC2/RC3)

Bergen handles with single-key MC-C inlays (RC2/RC3)

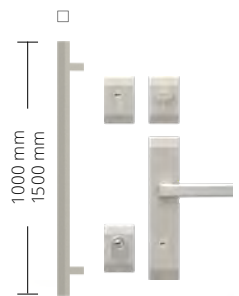

Amsterdam 1000 with B-A inlays (RC2/RC3)

Amsterdam 1000 with single-key MB-B inlays (RC2/RC3)

Amsterdam 1000 with single-key MC-C inlays (RC2/RC3)

Amsterdam 1500 with B-A inlays (RC2/RC3)

Amsterdam 1500 with single-key MB-B inlays (RC2/RC3)

Amsterdam 1500 with single-key MC-C inlays (RC2/RC3)

## COLOURS

WHITE FSB	GOLDEN OAK FDE	MAHOGANY FMA	ANTHRACITE FKG	DARK ANTHRACITE FKF
LIGHT CHESTNUT FRP	ALPINE CHESTNUT FRR	BRAZILIAN CHESTNUT FRB	WINCHESTER FDW	GREY STEEL FKZ





Bergen handles with B-A inlays (RC2/RC3)

Bergen handles with single-key MB-B inlays (RC2/RC3)

Bergen handles with single-key MC-C inlays (RC2/RC3)



ELA

Brig

## DOOR SIZES

**NTT 60** 80 | 90 E | 100 E  
**NTT 75** 80 | 90 E | 100 E



MODEL	NTT 60	NTT 75
ELA Brig one-sided panel	✓	✓

AVAILABLE FOR AN ADDITIONAL FEE	NTT 60	NTT 75
ALUTHERM frame	✓	✓
size 100 E	✓	✓
panel on the other side	✓	✓
RC3 package	✓	✓
shortening 0-40 mm	✓	✓

Fixed aluminium fanlights on page 70  
 Full list of available accessories on pages 74-75



ELB

Olten

## DOOR SIZES

**NTT 60** 80 | 90 E | 100 E  
**NTT 75** 80 | 90 E | 100 E



MODEL	NTT 60	NTT 75
ELB Olten one-sided panel	✓	✓

AVAILABLE FOR AN ADDITIONAL FEE	NTT 60	NTT 75
ALUTHERM frame	✓	✓
size 100 E	✓	✓
panel on the other side	✓	✓
RC3 package (NTT 75/3)	✓	✓
shortening 0-40 mm	✓	✓

Fixed aluminium fanlights on page 70  
 Full list of available accessories on pages 74-75

## COLOURS



WHITE FSB	GOLDEN OAK FDE	MAHOGANY FMA	ANTHRACITE FKG	DARK ANTHRACITE FKF
LIGHT CHESTNUT FRP	ALPINE CHESTNUT FRR	BRAZILIAN CHESTNUT FRB	WINCHESTER FDW	GREY STEEL FKZ



ELC Visp

**DOOR SIZES**

NTT 60 80 | 90 E | 100 E  
 NTT 75 80 | 90 E | 100 E



MODEL	NTT 60	NTT 75
ELC Visp one-sided panel	✓	✓

AVAILABLE FOR AN ADDITIONAL FEE	NTT 60	NTT 75
ALUTHERM frame	✓	✓
size 100 E	✓	✓
panel on the other side	✓	✓
RC3 package	✓	✓
shortening 0-40 mm	✓	✓

Fixed aluminium fanlights on page 70  
 Full list of available accessories on pages 74-75



Bergen handles with B-A inlays (RC2/RC3)

Bergen handles with single-key MB-B inlays (RC2/RC3)

Bergen handles with single-key MC-C inlays (RC2/RC3)



ELD Trin

**DOOR SIZES**

NTT 60 80 | 90 E | 100 E  
 NTT 75 80 | 90 E | 100 E



MODEL	NTT 60	NTT 75
ELD Trin one-sided panel	✓	✓

AVAILABLE FOR AN ADDITIONAL FEE	NTT 60	NTT 75
ALUTHERM frame	✓	✓
size 100 E	✓	✓
panel on the other side	✓	✓
RC3 package	✓	✓
shortening 0-40 mm	✓	✓

Fixed aluminium fanlights on page 70  
 Full list of available accessories on pages 74-75

**COLOURS**

WHITE FSB	GOLDEN OAK FDE	MAHOGANY FMA	ANTHRACITE FKG	DARK ANTHRACITE FKF
LIGHT CHESTNUT FRP	ALPINE CHESTNUT FRR	BRAZILIAN CHESTNUT FRB	WINCHESTER FDW	GREY STEEL FKZ





Bergen handles with B-A inlays (RC2/RC3)

Bergen handles with single-key MB-B inlays (RC2/RC3)

Bergen handles with single-key MC-C inlays (RC2/RC3)



ELE

Berno

### DOOR SIZES

**NTT 60** 80 | 90 E | 100 E  
**NTT 75** 80 | 90 E | 100 E

CLASSIC STRIP



MODERN STRIP



MODEL	NTT 60	NTT 75
ELE Berno one-sided panel	✓	✓

AVAILABLE FOR AN ADDITIONAL FEE	NTT 60	NTT 75
ALUTHERM frame	✓	✓
size 100 E	✓	✓
panel on the other side	✓	✓
RC3 package	✓	✓
shortening 0-40 mm	✓	✓

Fixed aluminium fanlights on page 70  
 Full list of available accessories on pages 74-75

### CLASSIC STRIP CROSS-SECTION



### MODERN STRIP CROSS-SECTION



### COLOURS



WHITE FSB	GOLDEN OAK FDE	MAHOGANY FMA	ANTHRACITE FKG	DARK ANTHRACITE FKF
LIGHT CHESTNUT FRP	ALPINE CHESTNUT FRR	BRAZILIAN CHESTNUT FRB	WINCHESTER FDW	GREY STEEL FKZ





NS1 Milano 8



NS2 Milano 9



NS9 Milano 12

**DOOR SIZES**

**NTT 60** 80 | 90 E | 100 E  
**NTT 75** 80 | 90 E | 100 E

**TT 60** 80 N | 80 | 90 N | 90 E | 100 E

**GLAZING**



MODEL	OPTIMA		REVO	
	TT 50	TT 60	NTT 60	NTT 75
NS1 Milano 8	(-)	✓	✓	✓
NS2 Milano 9	(-)	✓	✓	✓
NS9 Milano 12	(-)	✓	✓	✓

AVAILABLE FOR AN ADDITIONAL FEE	TT 50	TT 60	NTT 60	NTT 75
ALUTHERM frame	(-)	✓	✓	✓
size 100 E	(-)	✓	✓	✓
shortening 0-40 mm	(-)	✓	✓	✓

Available fanlights on pages 70-71  
 Full list of available accessories on pages 74-75  
 Double-sided design

**COLOURS**

WHITE FSB	GOLDEN OAK FDE	MAHOGANY FMA	ANTHRACITE FKG	DARK ANTHRACITE FKF
LIGHT CHESTNUT FRP	ALPINE CHESTNUT FRR	BRAZILIAN CHESTNUT FRB	WINCHESTER FDW	GREY STEEL FKZ

**NTT REVO**



Bergen handles with B-A inlays (RC2)

Bergen handles with single-key MB-B inlays (RC2)

Bergen handles with single-key MC-C inlays (RC2)

Amsterdam 1000 with B-A inlays (RC2)

Amsterdam 1000 with single-key MB-B inlays (RC2)

Amsterdam 1000 with single-key MC-C inlays (RC2)

Amsterdam 1500 with B-A inlays (RC2)

Amsterdam 1500 with single-key MB-B inlays (RC2)

Amsterdam 1500 with single-key MC-C inlays (RC2)



**TT OPTIMA**



Blok handles with A-A inlays

Blok handles with single-key MB-B inlays (RC2)

Montreal 1000 with A-A inlays

Montreal 1000 with single-key MB-B inlays (RC2)

Montreal 1500 with A-A inlays

Montreal 1500 with single-key MB-B inlays (RC2)



## NTT REVO



Bergen handles with B-A inlays (RC2)

Bergen handles with single-key MB-B inlays (RC2)

Bergen handles with single-key MC-C inlays (RC2)

Amsterdam 1000 with B-A inlays (RC2)

Amsterdam 1000 with single-key MB-B inlays (RC2)

Amsterdam 1000 with single-key MC-C inlays (RC2)

Amsterdam 1500 with B-A inlays (RC2)

Amsterdam 1500 with single-key MB-B inlays (RC2)

Amsterdam 1500 with single-key MC-C inlays (RC2)



## TT OPTIMA



Blok handles with A-A inlays

Blok handles with single-key MB-B inlays (RC2)

Montreal 1000 with A-A inlays

Montreal 1000 with single-key MB-B inlays (RC2)

Montreal 1500 with A-A inlays

Montreal 1500 with single-key MB-B inlays (RC2)



NS3

Milano 10



NS4

Milano 11

### DOOR SIZES

**NTT 60** 80 | 90 E | 100 E  
**NTT 75** 80 | 90 E | 100 E

**TT 60** 80 N | 80 | 90 N | 90 E | 100 E

### GLAZING



MODEL	OPTIMA		REVO	
	TT 50	TT 60	NTT 60	NTT 75
NS3 Milano 10	(-)	✓	✓	✓

AVAILABLE FOR AN ADDITIONAL FEE	TT 50	TT 60	NTT 60	NTT 75
ALUTHERM frame	(-)	✓	✓	✓
size 100 E	(-)	✓	✓	✓
shortening 0-40 mm	(-)	✓	✓	✓

Available fanlights on pages 70-71  
Full list of available accessories on pages 74-75  
Double-sided design

### DOOR SIZES

**NTT 60** 80 | 90 E | 100 E  
**NTT 75** 80 | 90 E | 100 E

**TT 60** 80 N | 80 | 90 N | 90 E | 100 E

### GLAZING

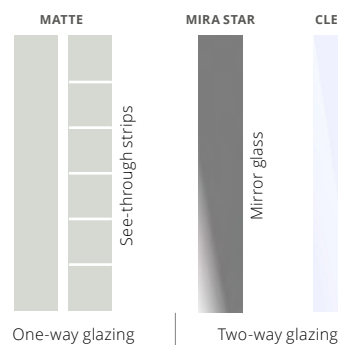

MODEL	OPTIMA		REVO	
	TT 50	TT 60	NTT 60	NTT 75
NS4 Milano 11	(-)	✓	✓	✓

AVAILABLE FOR AN ADDITIONAL FEE	TT 50	TT 60	NTT 60	NTT 75
ALUTHERM frame	(-)	✓	✓	✓
size 100 E	(-)	✓	✓	✓
shortening 0-40 mm	(-)	✓	✓	✓

Available fanlights on pages 70-71  
Full list of available accessories on pages 74-75  
Double-sided design

### COLOURS



WHITE FSB	GOLDEN OAK FDE	MAHOGANY FMA	ANTHRACITE FKG	DARK ANTHRACITE FKF
LIGHT CHESTNUT FRP	ALPINE CHESTNUT FRR	BRAZILIAN CHESTNUT FRB	WINCHESTER FDW	GREY STEEL FKZ



NS5 Hanover 5

**DOOR SIZES**

**NTT 60** 80 | 90 E | 100 E  
**NTT 75** 80 | 90 E | 100 E

**TT 60** 80 N | 80 | 90 N | 90 E | 100 E

**GLAZING**

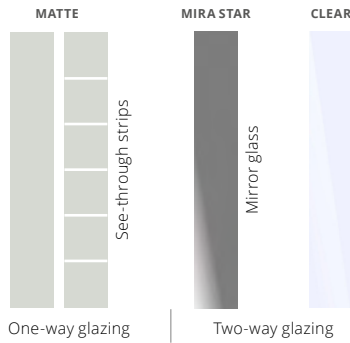

MODEL	OPTIMA		REVO	
	TT 50	TT 60	NTT 60	NTT 75
NS5 Hanover 5	(-)	✓	✓	✓

AVAILABLE FOR AN ADDITIONAL FEE	TT 50	TT 60	NTT 60	NTT 75
ALUTHERM frame	(-)	✓	✓	✓
size 100 E	(-)	✓	✓	✓
shortening 0-40 mm	(-)	✓	✓	✓

Available fanlights on pages 70-71  
 Full list of available accessories on pages 74-75  
 Double-sided design

**DOOR SIZES**

**NTT 60** 80 | 90 E | 100 E  
**NTT 75** 80 | 90 E | 100 E

**TT 60** 80 | 90 E | 100 E

**GLAZING**

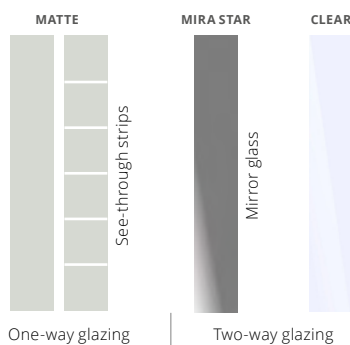

MODEL	OPTIMA		REVO	
	TT 50	TT 60	NTT 60	NTT 75
NS6 Hanover 6	(-)	✓	✓	✓

AVAILABLE FOR AN ADDITIONAL FEE	TT 50	TT 60	NTT 60	NTT 75
ALUTHERM frame	(-)	✓	✓	✓
size 100 E	(-)	✓	✓	✓
shortening 0-40 mm	(-)	✓	✓	✓

Available fanlights on pages 70-71  
 Full list of available accessories on pages 74-75  
 Double-sided design

**COLOURS**

WHITE FSB	GOLDEN OAK FDE	MAHOGANY FMA	ANTHRACITE FKG	DARK ANTHRACITE FKF
LIGHT CHESTNUT FRP	ALPINE CHESTNUT FRR	BRAZILIAN CHESTNUT FRB	WINCHESTER FDW	GREY STEEL FKZ

**NTT REVO**



Bergen handles with B-A inlays (RC2)

Bergen handles with single-key MB-B inlays (RC2)

Bergen handles with single-key MC-C inlays (RC2)

Amsterdam 1000 with B-A inlays (RC2)

Amsterdam 1000 with single-key MB-B inlays (RC2)

Amsterdam 1000 with single-key MC-C inlays (RC2)

Amsterdam 1500 with B-A inlays (RC2)

Amsterdam 1500 with single-key MB-B inlays (RC2)

Amsterdam 1500 with single-key MC-C inlays (RC2)



**TT OPTIMA**



Blok handles with A-A inlays

Blok handles with single-key MB-B inlays (RC2)

Montreal 1000 with A-A inlays

Montreal 1000 with single-key MB-B inlays (RC2)

Montreal 1500 with A-A inlays

Montreal 1500 with single-key MB-B inlays (RC2)



## NTT REVO



Bergen handles with B-A inlays (RC2)

Bergen handles with single-key MB-B inlays (RC2)

Bergen handles with single-key MC-C inlays (RC2)

Amsterdam 1000 with B-A inlays (RC2)

Amsterdam 1000 with single-key MB-B inlays (RC2)

Amsterdam 1000 with single-key MC-C inlays (RC2)

Amsterdam 1500 with B-A inlays (RC2)

Amsterdam 1500 with single-key MB-B inlays (RC2)

Amsterdam 1500 with single-key MC-C inlays (RC2)



## TT OPTIMA



Blok handles with A-A inlays

Blok handles with single-key MB-B inlays (RC2)

Montreal 1000 with A-A inlays

Montreal 1000 with single-key MB-B inlays (RC2)

Montreal 1500 with A-A inlays

Montreal 1500 with single-key MB-B inlays (RC2)



NS7

Innsbruck



NS8

Patra

### DOOR SIZES

**NTT 60** 80 | 90 E | 100 E  
**NTT 75** 80 | 90 E | 100 E

**TT 60** 80 N | 80 | 90 N | 90 E | 100 E

### GLAZING



MODEL	OPTIMA		REVO	
	TT 50	TT 60	NTT 60	NTT 75
NS7 Innsbruck	(-)	✓	✓	✓

AVAILABLE FOR AN ADDITIONAL FEE	TT 50	TT 60	NTT 60	NTT 75
ALUTHERM frame	(-)	✓	✓	✓
size 100 E	(-)	✓	✓	✓

Available fanlights on pages 70-71  
Full list of available accessories on pages 74-75  
Double-sided design

### DOOR SIZES

**NTT 60** 80 | 90 E | 100 E  
**NTT 75** 80 | 90 E | 100 E

**TT 60** 80 N | 80 | 90 N | 90 E | 100 E

### GLAZING

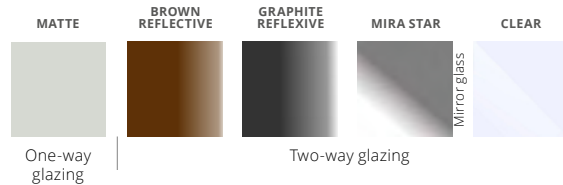

MODEL	OPTIMA		REVO	
	TT 50	TT 60	NTT 60	NTT 75
NS8 Patra	(-)	✓	✓	✓

AVAILABLE FOR AN ADDITIONAL FEE	TT 50	TT 60	NTT 60	NTT 75
ALUTHERM frame	(-)	✓	✓	✓
size 100 E	(-)	✓	✓	✓

Available fanlights on pages 70-71  
Full list of available accessories on pages 74-75  
Double-sided design

### COLOURS

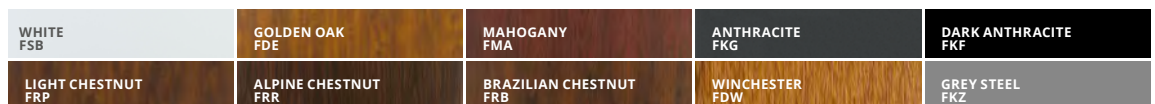



**DOOR SIZES**

**NTT 60** 80 | 90 E | 100 E  
**NTT 75** 80 | 90 E | 100 E

**TT 50** 80 N | 80 | | 90 E | 100 E  
**TT 60** 80 N | 80 | 90 N | 90 E | 100 E

MODEL	OPTIMA		REVO	
	TT 50	TT 60	NTT 60	NTT 75
W00 Flat surface	✓	✓	✓	✓

AVAILABLE FOR AN ADDITIONAL FEE	TT 50	TT 60	NTT 60	NTT 75
ALUTHERM frame	(-)	✓	✓	✓
Perfotherm® frame	✓	(-)	(-)	(-)
size 100 E	✓	✓	✓	✓
RC3 package	(-)	✓	✓	✓
shortening 0-100 mm	(-)	✓	✓	✓

Available fanlights on pages 70-71  
 Full list of available accessories on pages 74-75

**NTT REVO**



Bergen handles with B-A inlays (RC2/RC3)  
 Bergen handles with single-key MB-B inlays (RC2/RC3)  
 Bergen handles with single-key MC-C inlays (RC2/RC3)

- Amsterdam 1000 with B-A inlays (RC2/RC3)
- Amsterdam 1000 with single-key MB-B inlays (RC2/RC3)
- Amsterdam 1000 with single-key MC-C inlays (RC2/RC3)
- Amsterdam 1500 with B-A inlays (RC2/RC3)
- Amsterdam 1500 with single-key MB-B inlays (RC2/RC3)
- Amsterdam 1500 with single-key MC-C inlays (RC2/RC3)



**TT OPTIMA**

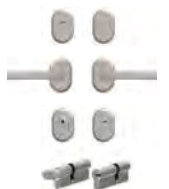

Blok handles with A-A inlays  
 Blok handles with single-key MB-B inlays (RC2/RC3)

- Montreal 1000 with A-A inlays
- Montreal 1000 with single-key MB-B inlays (RC2/RC3)
- Montreal 1500 with A-A inlays
- Montreal 1500 with single-key MB-B inlays (RC2/RC3)



**COLOURS**

WHITE FSB	GOLDEN OAK FDE	MAHOGANY FMA	ANTHRACITE FKG	DARK ANTHRACITE FKF
LIGHT CHESTNUT FRP	ALPINE CHESTNUT FRR	BRAZILIAN CHESTNUT FRB	WINCHESTER FDW	GREY STEEL FKZ





Blok handles with A-A inlays

Blok handles with single-key MB-B inlays (RC2)

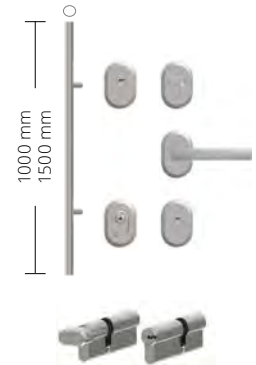

Montreal 1000 with A-A inlays

Montreal 1000 with single-key MB-B inlays (RC2)

Montreal 1500 with A-A inlays

Montreal 1500 with single-key MB-B inlays (RC2)



**SNUA Milano 4A**  
Stainless inserts



**SNU Milano 4**  
Pressed without inserts

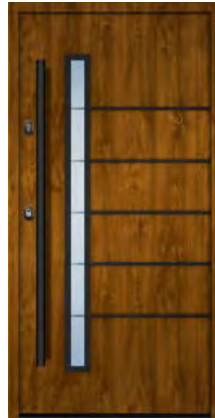

**SNUB Milano 4B**  
Black inserts

## DOOR SIZES

**TT 60** 80 N | 80 | 90 N | 90 E | 100 E

## GLAZING

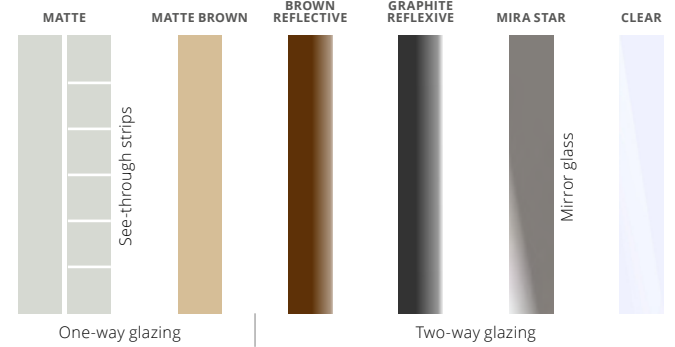

## MODEL

MODEL	TT 50	TT 60
SNU Milano 4	(-)	✓
SNUA Milano 4A	(-)	✓
SNUB Milano 4B	(-)	✓

## AVAILABLE FOR AN ADDITIONAL FEE

AVAILABLE FOR AN ADDITIONAL FEE	TT 50	TT 60
ALUTHERM OPTIMA frame	(-)	✓
size 100 E	(-)	✓
shortening 0-100 mm	(-)	✓

Available fanlights on pages 70-71

Full list of available accessories on pages 74-75

Double-sided design

## COLOURS

WHITE FSB	GOLDEN OAK FDE	MAHOGANY FMA	ANTHRACITE FKG	DARK ANTHRACITE FKF
LIGHT CHESTNUT FRP	ALPINE CHESTNUT FRR	BRAZILIAN CHESTNUT FRB	WINCHESTER FDW	GREY STEEL FKZ





SR2 Milano 15

**DOOR SIZES**

TT 60 80 N | 80 | 90 N | 90 E | 100 E

**GLAZING**

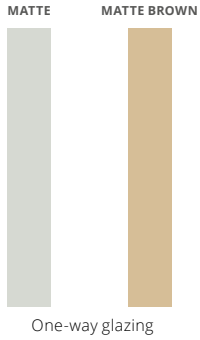

MODEL	TT 50	TT 60
SR1 Milano 14	(-)	✓
SR2 Milano 15	(-)	✓

AVAILABLE FOR AN ADDITIONAL FEE	TT 50	TT 60
ALUTHERM OPTIMA frame	(-)	✓
size 100 E	(-)	✓
shortening 0-40 mm	(-)	✓

Available fanlights on pages 70-71  
 Full list of available accessories on pages 74-75  
 Double-sided design



SR1 Milano 14



Blok handles with A-A inlays

Blok handles with single-key MB-B inlays (RC2)

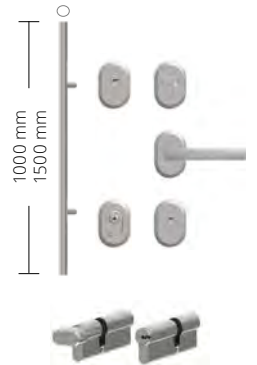

Montreal 1000 with A-A inlays

Montreal 1000 with single-key MB-B inlays (RC2)

Montreal 1500 with A-A inlays

Montreal 1500 with single-key MB-B inlays (RC2)

**COLOURS**

WHITE FSB	GOLDEN OAK FDE	MAHOGANY FMA	ANTHRACITE FKG	DARK ANTHRACITE FKF
LIGHT CHESTNUT FRP	ALPINE CHESTNUT FRR	BRAZILIAN CHESTNUT FRB	WINCHESTER FDW	GREY STEEL FKZ





**ST6** Narwik

### DOOR SIZES

**TT 60** 80 N | 80 | 90 N | 90 E | 100 E

### GLAZING

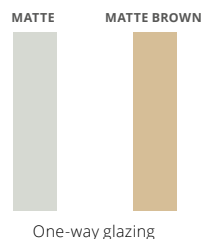

MODEL	TT 50	TT 60
ST6 Narwik	(-)	✓
ST6B Narwik B	(-)	✓

AVAILABLE FOR AN ADDITIONAL FEE	TT 50	TT 60
ALUTHERM OPTIMA frame	(-)	✓
size 100 E	(-)	✓
shortening 0-40 mm ST6	(-)	✓

Available fanlights on pages 70-71  
Full list of available accessories on pages 74-75  
Double-sided design

Black double-sided inserts



**ST7** Oslo

### DOOR SIZES

**TT 60** 80 N | 80 | 90 N | 90 E | 100 E

### GLAZING

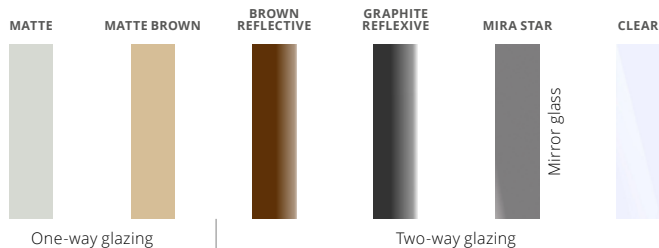

MODEL	TT 50	TT 60
ST7 Oslo	(-)	✓
ST7B Oslo B	(-)	✓

AVAILABLE FOR AN ADDITIONAL FEE	TT 50	TT 60
ALUTHERM OPTIMA frame	(-)	✓
size 100 E	(-)	✓
shortening 0-40 mm ST7	(-)	✓

Available fanlights on pages 70-71  
Full list of available accessories on pages 74-75  
Double-sided design

### COLOURS

WHITE FSB	GOLDEN OAK FDE	MAHOGANY FMA	ANTHRACITE FKG	DARK ANTHRACITE FKF
LIGHT CHESTNUT FRP	ALPINE CHESTNUT FRR	BRAZILIAN CHESTNUT FRB	WINCHESTER FDW	GREY STEEL FKZ



Blok handles with A-A inlays

Blok handles with single-key MB-B inlays (RC2)

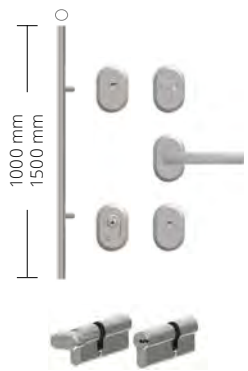

Montreal 1000 with A-A inlays

Montreal 1000 with single-key MB-B inlays (RC2)

Montreal 1500 with A-A inlays

Montreal 1500 with single-key MB-B inlays (RC2)







NT3 Turyн 3

**DOOR SIZES**

TT 60 80 N | 80 | 90 N | 90 E | 100 E

**GLAZING**



MODEL	TT 50	TT 60
NT1 Turyн 1	(-)	✓
NT2 Turyн 2	(-)	✓
NT3 Turyн 3	(-)	✓
NT1B Turyн 1B	(-)	✓
NT2B Turyн 2B	(-)	✓
NT3B Turyн 3B	(-)	✓

AVAILABLE FOR AN ADDITIONAL FEE	TT 50	TT 60
ALUTHERM OPTIMA frame	(-)	✓
size 100 E	(-)	✓

Available fanlights on pages 70-71  
 Full list of available accessories on pages 74-75  
 Double-sided design



NT1 Turyн 1



NT2 Turyн 2



NT1B Turyн 1B



NT2B Turyн 2B



NT3B Turyн 3B

**COLOURS**

WHITE FSB	GOLDEN OAK FDE	MAHOGANY FMA	ANTHRACITE FKG	DARK ANTHRACITE FKF
LIGHT CHESTNUT FRP	ALPINE CHESTNUT FRR	BRAZILIAN CHESTNUT FRB	WINCHESTER FDW	GREY STEEL FKZ



Blok handles with A-A inlays

Blok handles with single-key MB-B inlays (RC2)

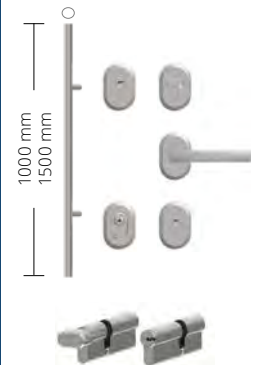

Montreal 1000 with A-A inlays

Montreal 1000 with single-key MB-B inlays (RC2)

Montreal 1500 with A-A inlays

Montreal 1500 with single-key MB-B inlays (RC2)





**SOJ Bergamo 2**  
Stainless inserts



**SOK Bergamo 3**  
Stainless inserts



**SOJB Bergamo 2B**  
Black inserts



**SOKB Bergamo 3B**  
Black inserts

## DOOR SIZES

**TT 50** 80 N | 80 | 90 N | 90 E | 100 E  
**TT 60** 80 N | 80 | 90 N | 90 E | 100 E

## GLAZING

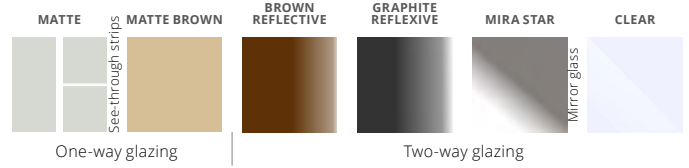

MODEL	TT 50	TT 60
SOJ Bergamo 2	(-)	✓
SOJB Bergamo 2B	(-)	✓
SOK Bergamo 3	✓	✓
SOKB Bergamo 3B	✓	✓

AVAILABLE FOR AN ADDITIONAL FEE	TT 50	TT 60
Perfotherm® frame	✓	(-)
ALUTHERM OPTIMA frame	(-)	✓
size 100 E	✓	✓
RC3 package (full designs)	(-)	✓

Available fanlights on pages 70-71  
 Full list of available accessories on pages 74-75  
 Double-sided design



Blok handles with A-A inlays

Blok handles with single-key MB-B inlays (RC2)

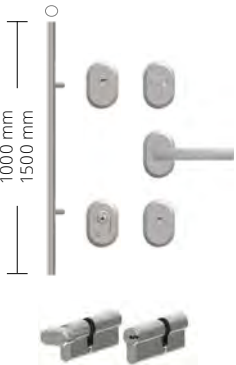

Montreal 1000 with A-A inlays

Montreal 1000 with single-key MB-B inlays (RC2)

Montreal 1500 with A-A inlays

Montreal 1500 with single-key MB-B inlays (RC2)



## COLOURS

WHITE FSB	GOLDEN OAK FDE	MAHOGANY FMA	ANTHRACITE FKG	DARK ANTHRACITE FKF
LIGHT CHESTNUT FRP	ALPINE CHESTNUT FRR	BRAZILIAN CHESTNUT FRB	WINCHESTER FDW	GREY STEEL FKZ

# TT OPTIMA TEMPO



**SJ9 Nicea 9**

## DOOR SIZES

**TT 50** 80 N | 80 | 90 N | 90 E | 100 E  
**TT 60** 80 N | 80 | 90 N | 90 E | 100 E

## GLAZING

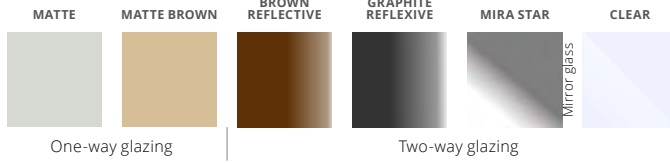

MODEL	TT 50	TT 60
SJ9 Nicea 9	(-)	✓
SJ9B Nicea 9B	(-)	✓
SJ7 Nicea 7	✓	✓
SJ7B Nicea 7B	✓	✓
SJ8 Nicea 8	(-)	✓
SJ8B Nicea 8B	(-)	✓

AVAILABLE FOR AN ADDITIONAL FEE	TT 50	TT 60
Perfotherm® frame	✓	(-)
ALUTHERM OPTIMA frame	(-)	✓
size 100 E	✓	✓
RC3 package (full designs)	(-)	✓
shortening 0-40mm SJ9; SJ7	✓	✓

Available fanlights on pages 70-71  
 Full list of available accessories on pages 74-75  
 Double-sided design



**SJ7 Nicea 7**



**SJ7B Nicea 7B**



**SJ8 Nicea 8**

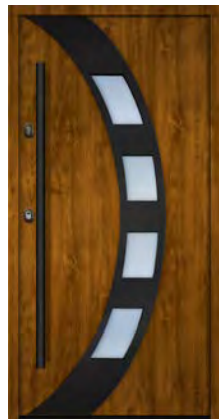

**SJ8B Nicea 8B**



**SJ9B Nicea 9B**

## COLOURS

WHITE FSB	GOLDEN OAK FDE	MAHOGANY FMA	ANTHRACITE FKG	DARK ANTHRACITE FKF
LIGHT CHESTNUT FRP	ALPINE CHESTNUT FRR	BRAZILIAN CHESTNUT FRB	WINCHESTER FDW	GREY STEEL FKZ

# NICEA



Blok handles with A-A inlays

Blok handles with single-key MB-B inlays (RC2)

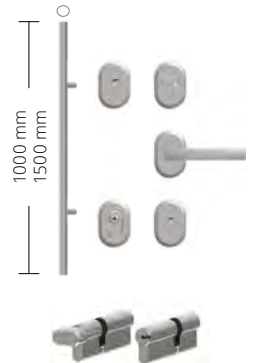

Montreal 1000 with A-A inlays

Montreal 1000 with single-key MB-B inlays (RC2)

Montreal 1500 with A-A inlays

Montreal 1500 with single-key MB-B inlays (RC2)

BLACK

PLATINUM

SILVER



Blok handles with A-A inlays

Blok handles with single-key MB-B inlays (RC2)

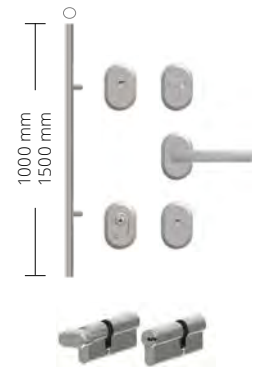

Montreal 1000 with A-A inlays

Montreal 1000 with single-key MB-B inlays (RC2)

Montreal 1500 with A-A inlays

Montreal 1500 with single-key MB-B inlays (RC2)



**SCF Patra 5**

Pressed without inserts



**SCFB Patra 5B**

Pressed without inserts

## DOOR SIZES

**TT 50** 80 N | 80 | 90 N | 90 E | 100 E

**TT 60** 80 N | 80 | 90 N | 90 E | 100 E

## GLAZING

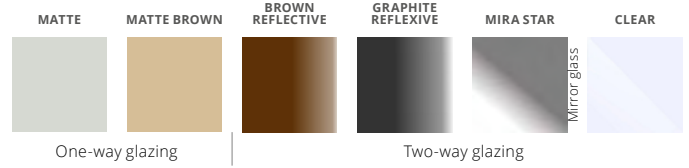

MODEL	TT 50	TT 60
SCF Patra 5	(-)	✓
SCFB Patra 5B	(-)	✓

AVAILABLE FOR AN ADDITIONAL FEE	TT 50	TT 60
ALUTHERM OPTIMA frame	(-)	✓
size 100 E	(-)	✓

Available fanlights on pages 70–71

Full list of available accessories on pages 74–75

Double-sided design



## COLOURS

WHITE FSB	GOLDEN OAK FDE	MAHOGANY FMA	ANTHRACITE FKG	DARK ANTHRACITE FKF
LIGHT CHESTNUT FRP	ALPINE CHESTNUT FRR	BRAZILIAN CHESTNUT FRB	WINCHESTER FDW	GREY STEEL FKZ



**SBE Berlin 4**



**SBEB Berlin 4B**

## DOOR SIZES

**TT 60** 80 N | 80 | 90 N | 90 E | 100 E

## GLAZING

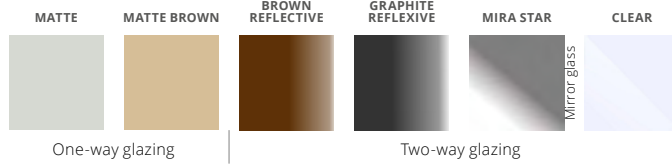

MODEL	TT 50	TT 60
SBE Berlin 4	(-)	✓
SBEB Berlin 4B	(-)	✓

AVAILABLE FOR AN ADDITIONAL FEE	TT 50	TT 60
ALUTHERM OPTIMA frame	(-)	✓
size 100 E	(-)	✓
shortening 0-100 mm	(-)	✓

Available fanlights on pages 70-71  
 Full list of available accessories on pages 74-75  
 Double-sided design



Blok handles with A-A inlays

Blok handles with single-key MB-B inlays (RC2)

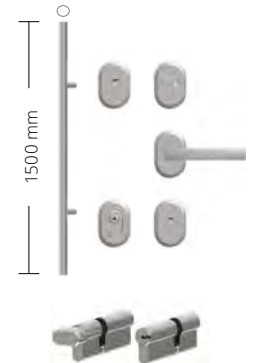

Montreal 1000 with A-A inlays

Montreal 1000 with single-key MB-B inlays (RC2)

Montreal 1500 with A-A inlays

Montreal 1500 with single-key MB-B inlays (RC2)

## COLOURS

WHITE FSB	GOLDEN OAK FDE	MAHOGANY FMA	ANTHRACITE FKG	DARK ANTHRACITE FKF
LIGHT CHESTNUT FRP	ALPINE CHESTNUT FRR	BRAZILIAN CHESTNUT FRB	WINCHESTER FDW	GREY STEEL FKZ



## DOOR SIZES

**TT 50** 80 N | 80 | 90 N | 90 E | 100 E  
**TT 60** 80 N | 80 | 90 N | 90 E | 100 E



**ST4A Uppsala 1A**  
Stainless inserts



**ST4 Uppsala 1**  
Pressed without inserts



**ST4B Uppsala 1B**  
Black inserts

MODEL	TT 50	TT 60
ST4 Uppsala 1	✓	✓
ST4A Uppsala 1A	✓	✓
ST4B Uppsala 1B	✓	✓

AVAILABLE FOR AN ADDITIONAL FEE	TT 50	TT 60
Perfotherm® frame	✓	(-)
ALUTHERM OPTIMA frame	(-)	✓
size 100 E	✓	✓
RC3 package (full designs)	(-)	✓

Available fanlights on pages 70-71  
 Full list of available accessories on pages 74-75  
 Double-sided design



Blok handles with A-A inlays

Blok handles with single-key MB-B inlays (RC2/RC3)

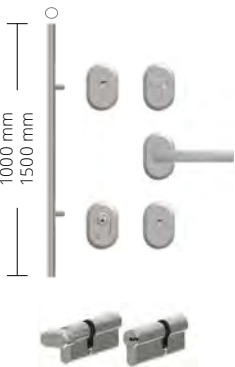

Montreal 1000 with A-A inlays

Montreal 1000 with single-key MB-B inlays (RC2/RC3)

Montreal 1500 with A-A inlays

Montreal 1500 with single-key MB-B inlays (RC2/RC3)



## COLOURS

WHITE FSB	GOLDEN OAK FDE	MAHOGANY FMA	ANTHRACITE FKG	DARK ANTHRACITE FKF
LIGHT CHESTNUT FRP	ALPINE CHESTNUT FRR	BRAZILIAN CHESTNUT FRB	WINCHESTER FDW	GREY STEEL FKZ

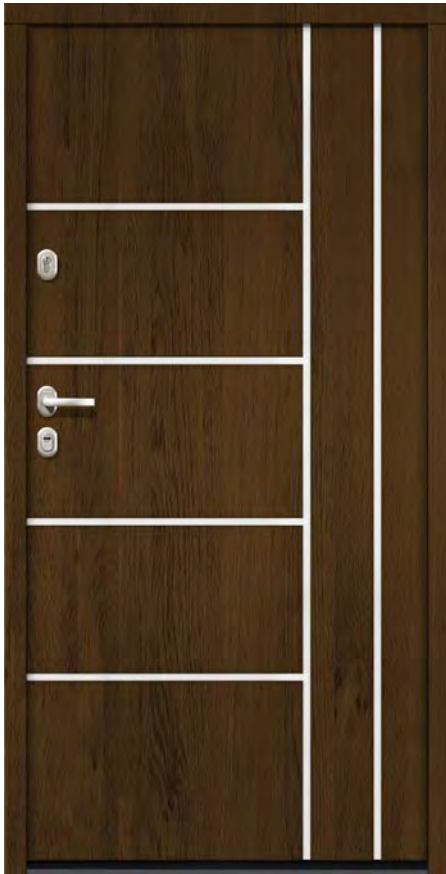

**ST5A Uppsala 2A**  
Stainless inserts



**ST5 Uppsala 2**  
Pressed without inserts



**ST5B Uppsala 2B**  
Black inserts

**DOOR SIZES**

**TT 50** 80 N | 80 | 90 N | 90 E | 100 E  
**TT 60** 80 N | 80 | 90 N | 90 E | 100 E

MODEL	TT 50	TT 60
ST5 Uppsala 2	✓	✓
ST5A Uppsala 2A	✓	✓
ST5B Uppsala 2B	✓	✓

AVAILABLE FOR AN ADDITIONAL FEE	TT 50	TT 60
Perfotherm® frame	✓	(-)
ALUTHERM OPTIMA frame	(-)	✓
size 100 E	✓	✓
RC3 package (full designs)	(-)	✓

Available fanlights on pages 70–71  
 Full list of available accessories on pages 74–75  
 Double-sided design



Blok handles with A-A inlays

Blok handles with single-key MB-B inlays (RC2/RC3)

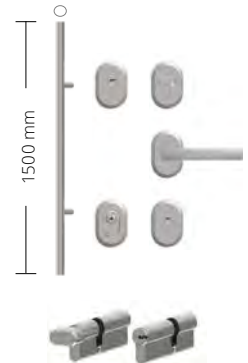

Montreal 1000 with A-A inlays

Montreal 1000 with single-key MB-B inlays (RC2/RC3)

Montreal 1500 with A-A inlays

Montreal 1500 with single-key MB-B inlays (RC2/RC3)

**COLOURS**

WHITE FSB	GOLDEN OAK FDE	MAHOGANY FMA	ANTHRACITE FKG	DARK ANTHRACITE FKF
LIGHT CHESTNUT FRP	ALPINE CHESTNUT FRR	BRAZILIAN CHESTNUT FRB	WINCHESTER FDW	GREY STEEL FKZ





Blok handles with A-A inlays

Blok handles with single-key MB-B inlays (RC2/RC3)

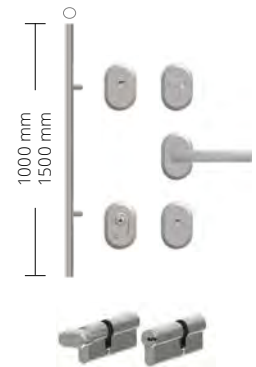

Montreal 1000 with A-A inlays

Montreal 1000 with single-key MB-B inlays (RC2/RC3)

Montreal 1500 with A-A inlays

Montreal 1500 with single-key MB-B inlays (RC2/RC3)



**TMMA** **Tokio 2A**

Stainless inserts



**TML** **Tokio 1**

Pressed without inserts



**TMM** **Tokio 2**

Pressed without inserts



**TMMB** **Tokio 2B**

Black inserts



**TMLA** **Tokio 1A**

Stainless inserts

## DOOR SIZES

**TT 50** 80 N | 80 | 90 N | 90 E | 100 E

**TT 60** 80 N | 80 | 90 N | 90 E | 100 E

MODEL	TT 50	TT 60
TML Tokio 1	✓	✓
TMLA Tokio 1A	✓	✓
TMLB Tokio 1B	✓	✓
TMM Tokio 2	✓	✓
TMMA Tokio 2A	✓	✓
TMMB Tokio 2B	✓	✓

AVAILABLE FOR AN ADDITIONAL FEE	TT 50	TT 60
Perfotherm® frame	✓	(-)
ALUTHERM OPTIMA frame	(-)	✓
size 100 E	✓	✓
RC3 package (full designs)	(-)	✓

Available fanlights on pages 70-71

Full list of available accessories on pages 74-75

Double-sided design

Door pull not available with versions TMM, TMMA, TMMB.



**TMLB** **Tokio 1B**

Black inserts

## COLOURS

WHITE FSB	GOLDEN OAK FDE	MAHOGANY FMA	ANTHRACITE FKG	DARK ANTHRACITE FKF
LIGHT CHESTNUT FRP	ALPINE CHESTNUT FRR	BRAZILIAN CHESTNUT FRB	WINCHESTER FDW	GREY STEEL FKZ







ST8 Ryga

**DOOR SIZES**

TT 50 80 N | 80 | 90 N | 90 E | 100 E  
 TT 60 80 N | 80 | 90 N | 90 E | 100 E

MODEL	TT 50	TT 60
ST8 Ryga	✓	✓

AVAILABLE FOR AN ADDITIONAL FEE	TT 50	TT 60
Perfotherm® frame	✓	(-)
ALUTHERM OPTIMA frame	(-)	✓
size 100 E	✓	✓
RC3 package (full designs)	(-)	✓

Available fanlights on pages 70-71  
 Full list of available accessories on pages 74-75  
 Double-sided design



Blok handles with A-A inlays

Blok handles with single-key MB-B inlays (RC2/RC3)



ST9 Lund

**DOOR SIZES**

TT 50 80 N | 80 | 90 N | 90 E | 100 E  
 TT 60 80 N | 80 | 90 N | 90 E | 100 E

MODEL	TT 50	TT 60
ST9 Lund	✓	✓

AVAILABLE FOR AN ADDITIONAL FEE	TT 50	TT 60
Perfotherm® frame	✓	(-)
ALUTHERM OPTIMA frame	(-)	✓
size 100 E	✓	✓
RC3 package (full designs)	(-)	✓

Available fanlights on pages 70-71  
 Full list of available accessories on pages 74-75  
 Double-sided design

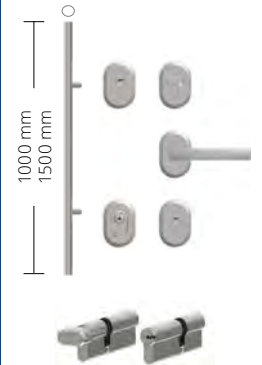

Montreal 1000 with A-A inlays

Montreal 1000 with single-key MB-B inlays (RC2/RC3)

Montreal 1500 with A-A inlays

Montreal 1500 with single-key MB-B inlays (RC2/RC3)

**COLOURS**

WHITE FSB	GOLDEN OAK FDE	MAHOGANY FMA	ANTHRACITE FKG	DARK ANTHRACITE FKF
LIGHT CHESTNUT FRP	ALPINE CHESTNUT FRR	BRAZILIAN CHESTNUT FRB	WINCHESTER FDW	GREY STEEL FKZ





Blok handles with A-A inlays

Blok handles with single-key MB-B inlays (RC2/RC3)

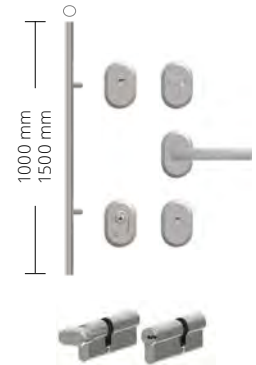

Montreal 1000 with A-A inlays

Montreal 1000 with single-key MB-B inlays (RC2/RC3)

Montreal 1500 with A-A inlays

Montreal 1500 with single-key MB-B inlays (RC2/RC3)



**TN7 Aspen 2**



**WBA Aspen 1**



**TN7B Aspen 2B**

## DOOR SIZES

**TT 50** 80 N | 80 | 90 N | 90 E | 100 E  
**TT 60** 80 N | 80 | 90 N | 90 E | 100 E

MODEL	TT 50	TT 60
WBA Aspen 1	✓	✓
TN7 Aspen 2	✓	✓
TN7B Aspen 2B	✓	✓

AVAILABLE FOR AN ADDITIONAL FEE	TT 50	TT 60
Perfotherm® frame	✓	(-)
ALUTHERM OPTIMA frame	(-)	✓
size 100 E	✓	✓
RC3 package (full designs)	(-)	✓
shortening 0-100 mm	✓	✓

Available fanlights on pages 70-71  
 Full list of available accessories on pages 74-75  
 Double-sided design



## COLOURS

WHITE FSB	GOLDEN OAK FDE	MAHOGANY FMA	ANTHRACITE FKG	DARK ANTHRACITE FKF
LIGHT CHESTNUT FRP	ALPINE CHESTNUT FRR	BRAZILIAN CHESTNUT FRB	WINCHESTER FDW	GREY STEEL FKZ

# TT OPTIMA TEMPO



**SR3 Tromso**



**SR4 Tromso 1**



**SR5 Tromso 2**

## DOOR SIZES

**TT 50** 80 N | 80 | 90 N | 90 E | 100 E  
**TT 60** 80 N | 80 | 90 N | 90 E | 100 E

MODEL	TT 50	TT 60
SR3 Tromso	✓	✓
SR4 Tromso 1	✓	✓
SR5 Tromso 2	✓	✓

AVAILABLE FOR AN ADDITIONAL FEE	TT 50	TT 60
Perfotherm® frame	✓	(-)
ALUTHERM OPTIMA frame	(-)	✓
size 100 E	✓	✓
RC3 package (full designs)	(-)	✓
shortening 0-40 mm SR4	✓	✓

Available fanlights on pages 70–71  
 Full list of available accessories on pages 74–75  
 Double-sided design

# TROMSO



Blok handles with A-A inlays

Blok handles with single-key MB-B inlays (RC2/RC3)

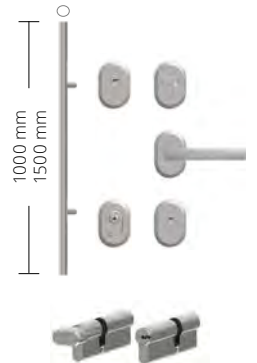

Montreal 1000 with A-A inlays

Montreal 1000 with single-key MB-B inlays (RC2/RC3)

Montreal 1500 with A-A inlays

Montreal 1500 with single-key MB-B inlays (RC2/RC3)

## COLOURS

WHITE FSB	GOLDEN OAK FDE	MAHOGANY FMA	ANTHRACITE FKG	DARK ANTHRACITE FKF
LIGHT CHESTNUT FRP	ALPINE CHESTNUT FRR	BRAZILIAN CHESTNUT FRB	WINCHESTER FDW	GREY STEEL FKZ



## DOOR SIZES

TT 60 80 | 90 N | 90 E

## GLAZING

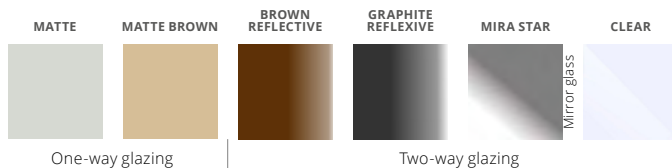

MODEL	TT 50	TT 60
W77 Modena 2	(-)	✓
W76 Modena	(-)	✓
W78 Modena 3	(-)	✓
WJ1 Nicea 5	(-)	✓
WDR Ravena	✓	✓

AVAILABLE FOR AN ADDITIONAL FEE	TT 50	TT 60
Perfotherm® frame	✓	(-)
ALUTHERM OPTIMA frame	(-)	✓
RC3 package (full designs)	(-)	✓
shortening 0-100 mm	✓	✓

Available fanlights on pages 70-71  
 Full list of available accessories on pages 74-75  
 Double-sided design



W78 Modena 3



W76 Modena



W77 Modena 2



WDR Ravena



WJ1 Nicea 5



Blok handles with A-A inlays

Blok handles with single-key MB-B inlays (RC2/RC3)

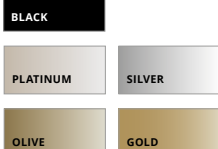

## COLOURS

WHITE FSB	GOLDEN OAK FDE	MAHOGANY FMA	ANTHRACITE FKG	DARK ANTHRACITE FKF
LIGHT CHESTNUT FRP	ALPINE CHESTNUT FRR	BRAZILIAN CHESTNUT FRB	WINCHESTER FDW	GREY STEEL FKZ



W23

Olympia

**DOOR SIZES**

TT 60 80 N | 80 | 90 N | 90 E | 100 E

**GLAZING**

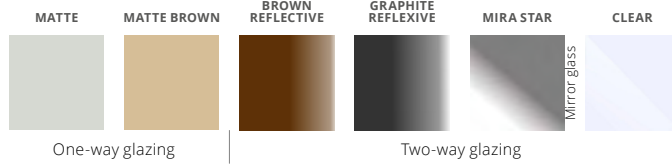

MODEL	TT 50	TT 60
W23 Olympia	(-)	✓

AVAILABLE FOR AN ADDITIONAL FEE	TT 50	TT 60
ALUTHERM OPTIMA frame	(-)	✓
size 100 E	(-)	✓
shortening 0-100 mm	(-)	✓

Available fanlights on pages 70-71  
 Full list of available accessories on pages 74-75  
 Double-sided design



Blok handles with A-A inlays

Blok handles with single-key MB-B inlays (RC2/RC3)



W29

Kolonia

**DOOR SIZES**

TT 60 80 N | 80 | 90 N | 90 E | 100 E

**GLAZING**

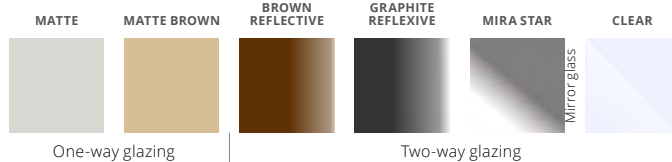

MODEL	TT 50	TT 60
W29 Kolonia	(-)	✓

  

AVAILABLE FOR AN ADDITIONAL FEE	TT 50	TT 60
ALUTHERM OPTIMA frame	(-)	✓
size 100 E	(-)	✓
shortening 0-100 mm	(-)	✓

Available fanlights on pages 70-71  
 Full list of available accessories on pages 74-75  
 Double-sided design

**COLOURS**

WHITE FSB	GOLDEN OAK FDE	MAHOGANY FMA	ANTHRACITE FKG	DARK ANTHRACITE FKF
LIGHT CHESTNUT FRP	ALPINE CHESTNUT FRR	BRAZILIAN CHESTNUT FRB	WINCHESTER FDW	GREY STEEL FKZ

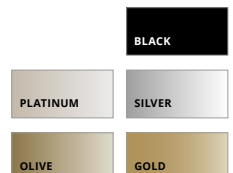



Blok handles with A-A inlays

Blok handles with single-key MB-B inlays (RC2/RC3)



**WQA Werona 5**



**W91 Werona**



**W94 Werona 1**



**W93 Werona 3**



**W6A Werona 4**

## DOOR SIZES

**TT 50** 80 | 90 N | 90 E  
**TT 60** 80 | 90 N | 90 E

## GLAZING

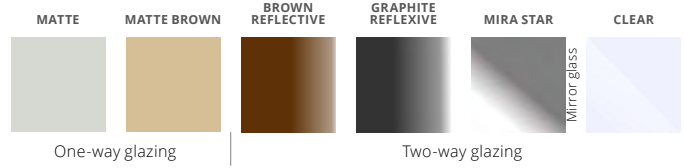

MODEL	TT 50	TT 60
WQA Werona 5	(-)	✓
W91 Werona	✓	✓
W94 Werona 1	(-)	✓
W93 Werona 3	(-)	✓
W6A Werona 4	(-)	✓

AVAILABLE FOR AN ADDITIONAL FEE	TT 50	TT 60
Perfotherm® frame	✓	(-)
ALUTHERM OPTIMA frame	(-)	✓
RC3 package (full designs)	(-)	✓
shortening 0-100 mm	✓	✓

Available fanlights on pages 70–71  
 Full list of available accessories on pages 74–75  
 Double-sided design

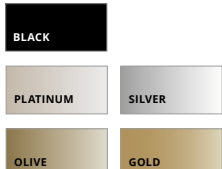

## COLOURS

WHITE FSB	GOLDEN OAK FDE	MAHOGANY FMA	ANTHRACITE FKG	DARK ANTHRACITE FKF
LIGHT CHESTNUT FRP	ALPINE CHESTNUT FRR	BRAZILIAN CHESTNUT FRB	WINCHESTER FDW	GREY STEEL FKZ



W24

Lizbona

**DOOR SIZES**

TT 50 80 | 90 N | 90 E  
 TT 60 80 | 90 N | 90 E

MODEL	TT 50	TT 60
W24 Lizbona	✓	✓

AVAILABLE FOR AN ADDITIONAL FEE	TT 50	TT 60
Perfotherm® frame	✓	(-)
ALUTHERM OPTIMA frame	(-)	✓
RC3 package (full designs)	(-)	✓
shortening 0-100 mm	✓	✓

Available fanlights on pages 70-71  
 Full list of available accessories on pages 74-75  
 Double-sided design



Blok handles with A-A inlays

Blok handles with single-key MB-B inlays (RC2/RC3)



W9N

Wenecja

**DOOR SIZES**

TT 50 80 | 90 N | 90 E  
 TT 60 80 | 90 N | 90 E

MODEL	TT 50	TT 60
W9N Wenecja	✓	✓

  

AVAILABLE FOR AN ADDITIONAL FEE	TT 50	TT 60
Perfotherm® frame	✓	(-)
ALUTHERM OPTIMA frame	(-)	✓
RC3 package (full designs)	(-)	✓
shortening 0-100 mm	✓	✓

Available fanlights on pages 70-71  
 Full list of available accessories on pages 74-75  
 Double-sided design

**COLOURS**

WHITE FSB	GOLDEN OAK FDE	MAHOGANY FMA	ANTHRACITE FKG	DARK ANTHRACITE FKF
LIGHT CHESTNUT FRP	ALPINE CHESTNUT FRR	BRAZILIAN CHESTNUT FRB	WINCHESTER FDW	GREY STEEL FKZ

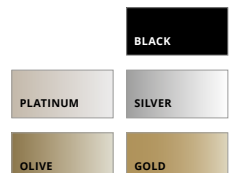



Blok handles with A-A inlays

Blok handles with single-key MB-B inlays (RC2/RC3)



**W5L** Londyn 1



**W13** Londyn

### DOOR SIZES

**TT 50** 80 | 90 N | 90 E  
**TT 60** 80 | 90 N | 90 E

### GLAZING

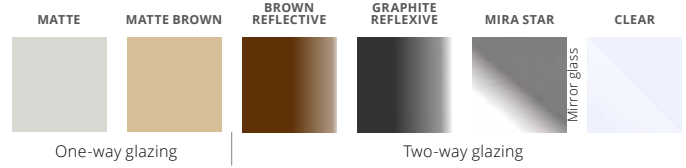

MODEL	TT 50	TT 60
W5L Londyn 1	(-)	✓
W13 Londyn	✓	✓

AVAILABLE FOR AN ADDITIONAL FEE	TT 50	TT 60
Perfotherm® frame	✓	(-)
ALUTHERM OPTIMA frame	(-)	✓
RC3 package (full designs)	(-)	✓
shortening 0-100 mm	✓	✓

Available fanlights on pages 70-71  
 Full list of available accessories on pages 74-75  
 Double-sided design



### COLOURS

WHITE FSB	GOLDEN OAK FDE	MAHOGANY FMA	ANTHRACITE FKG	DARK ANTHRACITE FKJ
LIGHT CHESTNUT FRP	ALPINE CHESTNUT FRR	BRAZILIAN CHESTNUT FRB	WINCHESTER FDW	GREY STEEL FKZ





W53 Barcelona 1



W54 Barcelona

**DOOR SIZES**

TT 50 80 | 90 N | 90 E  
 TT 60 80 | 90 N | 90 E

**GLAZING**

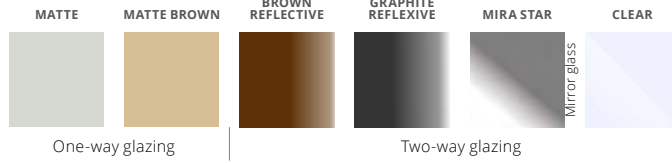

MODEL	TT 50	TT 60
W53 Barcelona 1	(-)	✓
W54 Barcelona	✓	✓

AVAILABLE FOR AN ADDITIONAL FEE	TT 50	TT 60
Perfotherm® frame	✓	(-)
ALUTHERM OPTIMA frame	(-)	✓
RC3 package (full designs)	(-)	✓
shortening 0-100 mm	✓	✓

Available fanlights on pages 70-71  
 Full list of available accessories on pages 74-75  
 Double-sided design



Blok handles with A-A inlays

Blok handles with single-key MB-B inlays (RC2/RC3)

**COLOURS**

WHITE FSB	GOLDEN OAK FDE	MAHOGANY FMA	ANTHRACITE FKG	DARK ANTHRACITE FKF
LIGHT CHESTNUT FRP	ALPINE CHESTNUT FRR	BRAZILIAN CHESTNUT FRB	WINCHESTER FDW	GREY STEEL FKZ

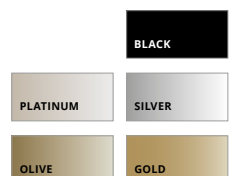



Blok handles with A-A inlays

Blok handles with single-key MB-B inlays (RC2/RC3)



**G75** Genewa 2



**D75** Genewa 3



**G76** Genewa 1

## DOOR SIZES

**TT 50** 80 N | 80 | 90 N | 90 E | 100 E  
**TT 60** 80 N | 80 | 90 N | 90 E | 100 E

## GLAZING

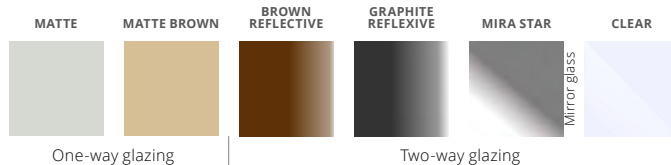

MODEL	TT 50	TT 60
G75 Genewa 2	(-)	✓
D75 Genewa 3	✓	✓
G76 Genewa 1	(-)	✓

AVAILABLE FOR AN ADDITIONAL FEE	TT 50	TT 60
Perfotherm® frame	✓	(-)
ALUTHERM OPTIMA frame	(-)	✓
size 100 E	(-)	✓
RC3 package (full designs)	(-)	✓
shortening 0-100 mm	✓	✓

Available fanlights on pages 70-71  
 Full list of available accessories on pages 74-75  
 Double-sided design, shallow embossing

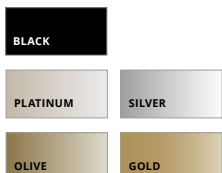

## COLOURS

WHITE FSB	GOLDEN OAK FDE	MAHOGANY FMA	ANTHRACITE FKG	DARK ANTHRACITE FKF
LIGHT CHESTNUT FRP	ALPINE CHESTNUT FRR	BRAZILIAN CHESTNUT FRB	WINCHESTER FDW	GREY STEEL FKZ

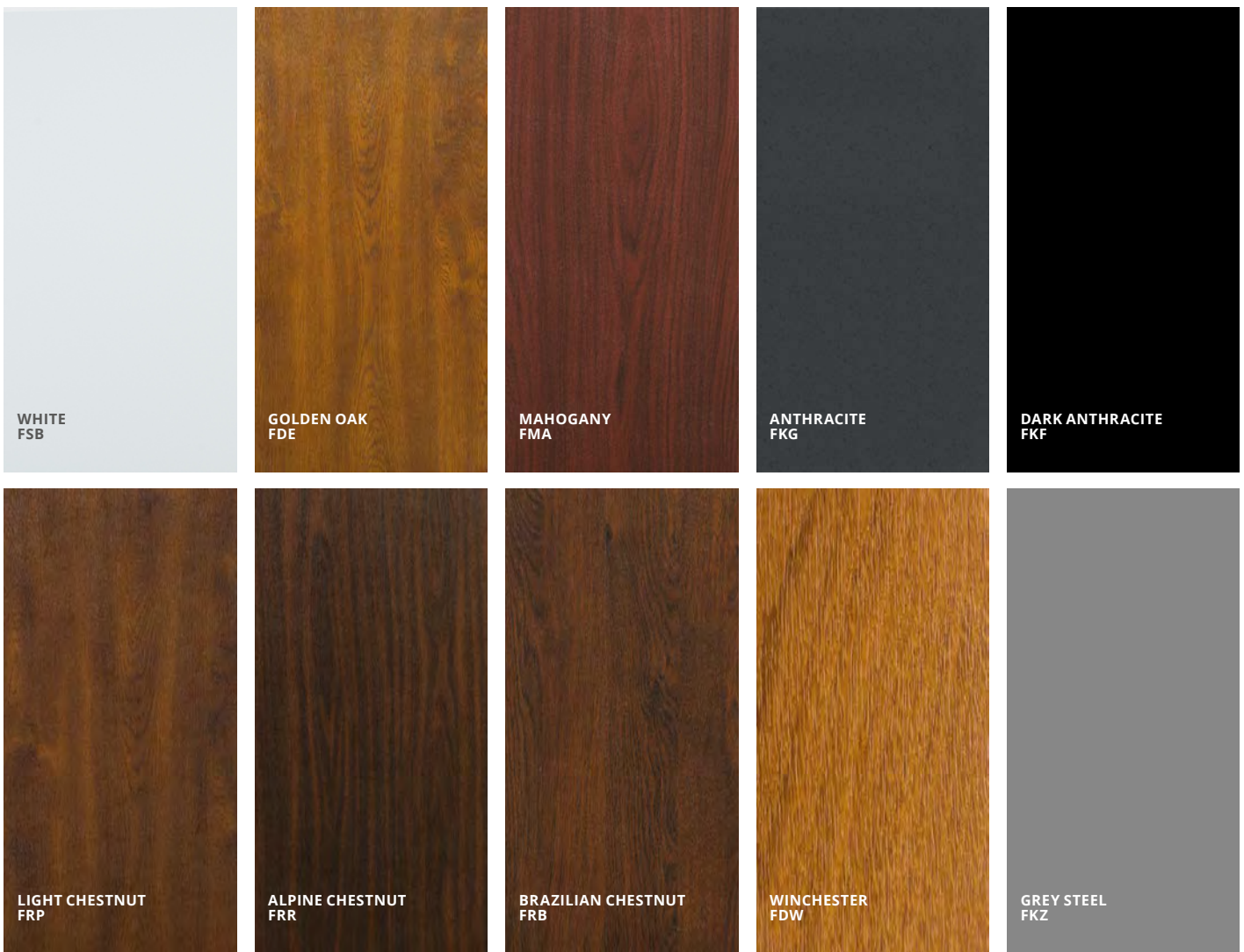

The door designs presented in this brochure are available in the above colours.

Leaf and frame veneers (double-sided PVC foil).

Details on the doors (second colour on NTT REVO doors) are available in all door veneer colours plus inox and black.

Two-coloured doors are available for an additional fee.

PERFOTHERM® and DUOTHERM frames are available in single colour only. ALUTHERM and ALUTHERM OPTIMA frames are available in double colour without an additional fee.

Slight variations in the colour of veneer may occur between individual product lots due to the nature of the material and the manufacturing process.

# TT OPTIMA DUO 60 DOORS

TT OPTIMA DUO 60 are a great choice for those looking for doors with non-standard dimensions. The use of a so-called passive leaf makes it possible to save space. The passive leaf is available both solid and glazed; a glazed leaf also serves as a side fanlight.

## Parameters

- designed to serve as entrance doors in single- and multi-family buildings; 61 mm-thick steel leaves filled with modified expanded polystyrene;
- available bundled with a PERFOTHERM® steel frame and an aluminium threshold;
- optionally delivered with an ALUTHERM OPTIMA aluminium frame for an additional fee; passive leaves available in solid and glazed versions, in sizes 30, 40, 50;
- doors available in 10 colours;

External frame and assembly opening dimensions are given on page 77.



## PASSIVE LEAF DESIGNS

NAME	SIZE	
P00	30 40 50	✓
PD4	40	✓
GH1	40 50	✓
GC2	40 50	✓
GN5	30 40 50	✓
GPD	30 40 50	✓
DN3 / DN3B	30 40 50	✓
DN6	30 40 50	✓
DW9	30 40 50	✓
DW8	30 40 50	✓
DPE / DPEB	30 40 50	✓
DC3 / DC3B	40 50	✓



P00



PD4



GH1



GC2



GN5



GPD



DN3 DN3B



DN6



DW9



DW8



DPE DPEB



DC3 DC3B

Passive leaves designs with inserts available for door leaves with the same pattern motif

NAME	SIZE	
PD5	30 40 50	✓
PD5A		
PD5B		
NMB		
NMBA		
NMBB		
NMA		
NMAA		
NMAB		



PD5



PD5A



PD5B



NMB



NMBA



NMBB



NMA



NMAA



NMAB

## TECHNICAL INFORMATION/PROS

### Aluminium fanlights

- a warm profile of the ALUTHERM door frame manufactured by GERDA
- aluminium fanlights are made of warm aluminium ALUTHERM profiles
- the use of extended thermal bridges ensures that fanlights possess excellent thermal insulation parameters
- the fanlights feature a warm three-pane set with a P2 or P4 or safe glass
- available in all the same colours as NTT REVO and TT OPTIMA doors
- the set can be produced in two different colours (on the inside/outside)
- comes with a modern warm and weather-resistant aluminium or PVC threshold
- the design of the door frames enables the installation of doors that swing out or in

### Steel fanlights

- frame and profiles are manufactured using the PERFO-THERM® system; PERFO-THERM® is a patented method of perforating profiles with a high level of heat insulation while maintaining their durability parameters.
- the fanlights feature a warm two-pane set with safe or P2 glass
- available in all the same colours as TT OPTIMA 60 doors
- comes with a modern weather-resistant aluminium threshold the design of the frames enables the installation of doors that swing out or in

## GLAZING COLOURS

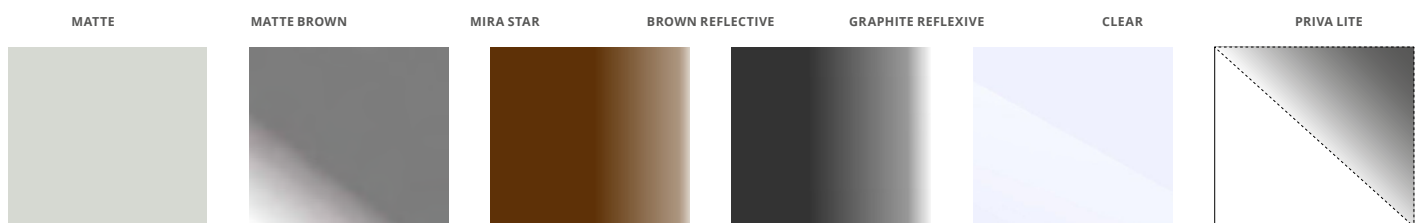

## PRIVA-LITE®\*

PRIVA-LITE® is a modern liquid crystal glass that can instantly turn from matte\*\* to transparent with one click, without any changes in light penetration parameters.

PRIVA-LITE® affords you a sense of full privacy, comfort and safety, without negatively affecting the light penetration parameters of the glass.

\* option available only with NTT REVO and aluminium fanlights

\*\* the matte form of PRIVA-LITE® glass is not exactly the same colour as the optional matte glazing of the door leaf

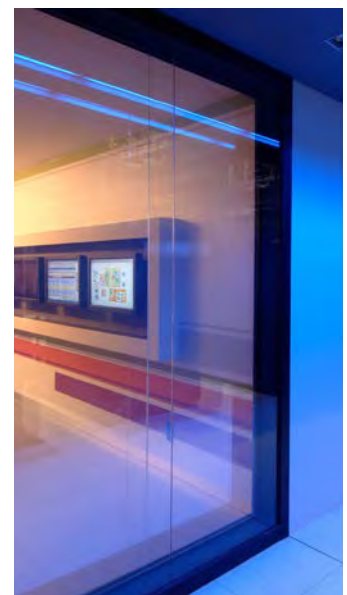

# ALUMINIUM FANLIGHT NTT REVO AND TT OPTIMA 60 DOORS

## AVAILABLE FANLIGHT VARIANTS



## EXTERNAL DIMENSIONS OF THE FRAME

### ALUTHERM FRAME - DIMENSIONS

Size	Height Hz	Width B
<b>80N</b>	2087 mm	888 mm
<b>80</b>		918 mm
<b>90N</b>		988 mm
<b>90E</b>		1031 mm
<b>100E</b>		1131 mm

### SIDE FANLIGHTS

Height Hz	Width Ld/Pd	200 mm – 400 mm	405 mm – 600 mm	605 mm – 900 mm	External glazing
		2087 mm	✓	✓	✓
		✓	✓	✓	burglar resistant P2
		✓	✓	✓	Priva Lite burglar resistant P2*
		Additional fee added to the price of a fanlight with a P2 glazing			burglar resistant P4 (optionally custom-made)

\* Priva Lite burglar resistant P2 = glazing package Priva Lite burglar resistant P2 + power supply unit + 10 m power supply cable + wireless switch. Priva Lite package is available only with side fanlights and NTT REVO doors

### TOP FANLIGHTS

Height	Width Ld/B/Pd	918 mm – 1100 mm	1105 mm – 1310 mm	1315 mm – 1520 mm	1525 mm – 1730 mm	1735 mm – 1940 mm	1945 mm – 2150 mm	2155 mm – 2360 mm	2365 mm – 2570 mm	External glazing
		Hc	Hd							
2287 – 2437 mm	200 – 350 mm	✓	✓	✓	✓	✓	✓	✓	✓	safe
2442 – 2587 mm	355 – 500 mm	✓	✓	✓	✓	✓	✓	✓	✓	
2287 – 2437 mm	200 – 350 mm	✓	✓	✓	✓	✓	✓	✓	✓	burglar proof P2
2442 – 2587 mm	355 – 500 mm	✓	✓	✓	✓	✓	✓	✓	✓	
2287 – 2437 mm	200 – 350 mm	Additional fee added to the price of a fanlight with a P2 glazing								burglar proof P4
2442 – 2587 mm	355 – 500 mm									

# STEEL FANLIGHTS TT OPTIMA 60 DOORS

## AVAILABLE FANLIGHT VARIANTS



## EXTERNAL DIMENSIONS OF THE FRAME

### PERFOTHERM FRAME - DIMENSIONS

Size	Height Hz	Width B
<b>80N</b>	2076 mm	866 mm
<b>80</b>		896 mm
<b>90N</b>		966 mm
<b>90E</b>		1009 mm
<b>100E</b>		1109 mm

### SIDE FANLIGHTS

Height Hz	Width Ld/Pd		External glazing
	300 mm	500 mm	
2076 mm	✓	✓	safe
	✓	✓	burglar proof P2

### TOP FANLIGHTS

Height	Width Ld/B/Pd	Doświetle boczne (Ld/Lb)	BRAK	300 mm	500 mm	300 mm +300 mm	300 mm +500 mm	500 mm +500 mm	External glazing
		DOORS "80"	650 mm	1196 mm	1396 mm	1496 mm	1696 mm	1896 mm	
		DOORS "90E"	1009 mm	1309 mm	1509 mm	1609 mm	1809 mm	2009 mm	
		DOORS "100E"	1109 mm	1409 mm	1609 mm	1709 mm	1909 mm	2109 mm	
Hc	Hd								
2376 mm	300 mm		✓	✓	✓	✓	✓	✓	safe
			✓	✓	✓	✓	✓	✓	burglar proof P2

# NTT REVO ACCESSORY SETS

## BERGEN HANDLE SETS

- The set includes a full package of components needed to equip the door
- Specifications given in the table.

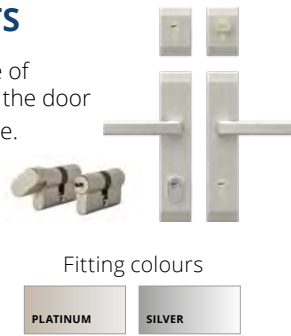

ACCESSORY SET	BERGEN B-A	BERGEN MB-B	BERGEN MC-C
	✓	✓	✓
Main lock inlay	EVO	EVO	PROSYSTEM
Additional locking handle inlay	WKE1	EVO	PROSYSTEM
Unprotected Bergen top inlay escutcheon*			
Protected Bergen top inlay escutcheon with handles			
Decorative hinge caps in the same colour as the escutcheons			

\*protected upper inlay escutcheon available only with set MB-B for an additional fee

## AMSTERDAM PULL AND HANDLE SETS

- The set includes a full package of components needed to equip the door.
- Specifications given in the table.
- Only for RC2-class doors.
- Not available for ELITE 3D series.

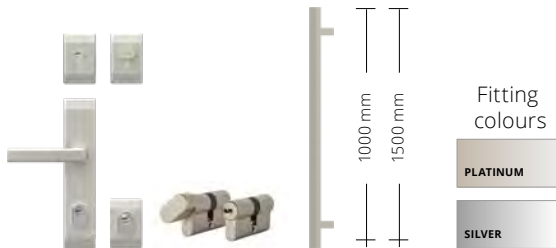

ACCESSORY SET	AMSTERDAM 1000 B-A	AMSTERDAM 1000 MB-B	AMSTERDAM 1000 MC-C
	✓	✓	✓
ACCESSORY SET	AMSTERDAM 1500 B-A	AMSTERDAM 1500 MB-B	AMSTERDAM 1000 MC-C
	✓	✓	✓

Main lock inlay	EVO	EVO	PROSYSTEM
Additional locking handle inlay	WKE1	EVO	PROSYSTEM
Amsterdam 1500 mm square door pull			
Unprotected Bergen top inlay escutcheon*			
Protected Bergen top inlay escutcheon with handles			
Decorative hinge caps in the same colour as the escutcheons			

\*protected upper inlay escutcheon available only with set MB-B for an additional fee

WKE1 basic inlay



EVO class 5.1.B burglar-proof inlay



PROSYSTEM burglar-proof inlay



EVO single key system 5.1.B burglar-proof class



AVAILABLE INLAYS	MAIN LOCK INLAY			MAIN LOCK INLAY		
	MODEL	SIZE		MODEL	SIZE	
NTT REVO 60	WKE1 basic inlay	35/50	✓	WKE1 locking handle	G35/50	✓
	EVO class 5.1.B burglar-proof inlay	35/50	✓	EVO locking handle	G50/35	✓
	EVO single- key system	35/50		bundled with	G35/50	✓
	PROSYSTEM single- key system	35/50		bundled with	G50/35	✓
				bundled with	G35/50	✓
NTT REVO 60 RC3	EVO class 5.1.B burglar-proof inlay with a gear rack	35/50Z	✓	WKE1 locking handle	G35/50	✓
				EVO locking handle	G50/35	✓
	EVO single- key system	35/50Z		bundled with	G35/50	✓
	PROSYSTEM single- key system	35/50Z		bundled with	G50/35	✓
				bundled with	G35/50	✓
NTT REVO 75	EVO class 5.1.B burglar-proof inlay with a gear rack	45/55Z	✓	WKE1 locking handle	G45/55	✓
				EVO locking handle	G55/45	✓
	EVO single key system	45/55Z		bundled with	G45/55	✓
	PROSYSTEM single- key system	45/55Z		bundled with	G55/45	✓
				bundled with	G45/55	✓



# TT OPTIMA ACCESSORY SETS

## BLOK HANDLE SETS

- The set includes a full package of components needed to equip the door
- Specifications given in the table.



Fitting colours



ACCESSORY SET	HANDLE/HANDLE	
	BLOK A-A	BLOK MB-B
	✓	✓

ACCESSORY SET	HANDLE/KNOB	
	BLOK A-A	BLOK MB-B
	✓	✓

Main lock inlay	WKE1	EVO <small>single key system</small>
Additional locking handle inlay	WKE1	EVO
Main inlay escutcheon	unprotected	protected
Top inlay escutcheon	unprotected	unprotected*

\*additional fee for a protected escutcheon

## MONTREAL HANDLE AND PULL SETS

- The set includes a full package of components needed to equip the door
- Specifications given in the table.



Fitting colours

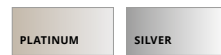

ACCESSORY SET	MONTREAL 1000 A-A	MONTREAL 1000 MB-B
	✓	✓

Main lock inlay	EVO	EVO <small>single key system</small>
Additional locking handle inlay	WKE1	EVO
MONTREAL 1000 mm door pull CIRCULAR		
Main inlay escutcheon	unprotected	protected
Top inlay escutcheon	unprotected	unprotected*

\*additional fee for a protected escutcheon

ACCESSORY SET	MONTREAL 1500 B-A	MONTREAL 1500 MB-B
	✓	✓

Main lock inlay	EVO	EVO <small>single key system</small>
Additional locking handle inlay	WKE1	EVO
Main inlay escutcheon	unprotected	protected
Top inlay escutcheon	unprotected	unprotected*

\*additional fee for a protected escutcheon

WKE1 basic inlay

















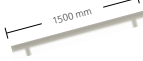

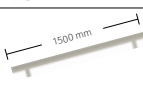
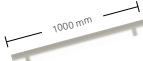
EVO single key system  
5.1.B burglar-proof class



AVAILABLE INLAYS	MAIN LOCK INLAY			ADDITIONAL LOCK INLAY		
	MODEL	SIZE		MODEL	SIZE	
TT OPTIMA 50	WKE1 basic inlay	30/45	✓	WKE1 knob	G30/45	✓
	EVO class 5.1.B burglar-proof inlay	30/45	✓	WKE1 knob	G45/30	✓
					G30/45	✓
	EVO set – single key system	30/45			G45/30	✓
TT OPTIMA 60	WKE1 basic inlay	35/50	✓	WKE1 knob	G35/50	✓
					G50/35	
	EVO class 5.1.B burglar-proof inlay	35/50	✓	WKE1 knob	G35/50	✓
					G50/35	
	EVO single key system	35/50			G35/50	✓
G50/35						
TT OPTIMA 60 RC3	EVO single key system	35/50Z			G35/50	✓
		35/50Z			G50/35	

# OPTIONAL ACCESSORIES

AVAILABLE FOR AN ADDITIONAL FEE DO DOORS	TT OPTIMA		NTT REVO	
	TT 50	TT 60	NTT 60	NTT 75
Electric doorstrike with a night/day function, factory installed in the frame (fee added to the door price); recommended for doors with pulls	✓	✓	✓	✓
Electric strike with day/night function installed in the passive DUO door leaf recommended for the door with handrails	(-)	✓	(-)	(-)
Reed relay factory installed in the frame	(-)	(-)	✓	✓
Shortening the door by 0 – 100 (selected designs only)	✓	✓	✓	✓
Two-colour door leaf	✓	✓	✓	✓
Internal reinforcement of the door leaf to accommodate a surface-mounted door closer (subject to an additional charge)	✓	✓	✓	✓
Capable of accommodating a door pull with a pushbutton	✓	✓	✓	✓

ADDITIONAL ACCESSORIES		TT OPTIMA		NTT REVO	
		TT 50	TT 60	NTT 60	NTT 75
BERGEN – unprotected inlay escutcheon, set		(-)	(-)	✓	✓
BERGEN – protected inlay escutcheon, set		(-)	(-)	✓	✓
BERGEN – one-sided handle		(-)	(-)	✓	✓
BERGEN – double-sided handle		(-)	(-)	✓	✓
AMSTERDAM square pull 1500		(-)	(-)	✓	✓
AMSTERDAM square pull 1000		(-)	(-)	✓	✓
AMSTERDAM square pull with a pushbutton 1500, electric doorstrike required		(-)	(-)	✓	✓
AMSTERDAM square pull with a pushbutton 1000, electric doorstrike required		(-)	(-)	✓	✓
BLOK – unprotected inlay escutcheon, set *		✓	✓	(-)	(-)
BLOK – protected inlay escutcheon, set *		✓	✓	(-)	(-)
BLOK – handle – handle *		✓	✓	(-)	(-)
BLOK – handle + knob *		✓	✓	(-)	(-)
MONTREAL round pull 1500		✓	✓	(-)	(-)
MONTREAL round pull 1000		✓	✓	(-)	(-)
MONTREAL round pull with a pushbutton 1500 electric doorstrike required		✓	✓	(-)	(-)
MONTREAL round pull with a pushbutton 1000 electric doorstrike required		✓	✓	(-)	(-)
Wide-angle door viewer 50/80		✓	✓	✓	✓
Electronic door-viewer		✓	✓	✓	✓

\* colours available: olive, gold, platinum, silver, black

# OPTIONAL ACCESSORIES

ADDITIONAL ACCESSORIES		TT OPTIMA		NTT REVO	
		TT 50	TT 60	NTT 60	NTT 75
Numerical access control keyboard		✓	✓	✓	✓
AWZ200 uninterruptible power supply		✓	✓	✓	✓
PSC12015 switched-mode power supply		✓	✓	✓	✓
Lower trim plate		✓	✓	(-)	(-)
GT 1500 standard door closer		✓	✓	✓	✓
GT 1500 self-locking door closer		✓	✓	✓	✓
Decorative aluminium hinge caps		✓	✓	✓	✓
Aluminium threshold for TT OPTIMA		✓	✓	(-)	(-)
Insulating threshold for NTT REVO		(-)	(-)	✓	✓
Insulating PVC threshold for NTT REVO		(-)	(-)	✓	✓
Wooden threshold		✓	✓	(-)	(-)
30 mm under threshold extension (mb)		✓	✓	✓	✓
Steel and wood 30mm side jamb extensions (for frames PERFOTHERM, DUOTHERM)		✓	✓	✓	✓
Steel and wood 60mm side jamb extensions (for frames PERFOTHERM, DUOTHERM)		✓	✓	✓	✓
Aluminium 28mm side jamb extensions (for the Alutherm door frame and aluminum funlight)		(-)	✓	✓	✓
Aluminium 52mm side jamb extensions (for the Alutherm door frame and aluminum funlight)		(-)	✓	✓	✓
Aluminium 114mm side jamb extensions (for the Alutherm door frame and aluminum funlight)		(-)	✓	✓	✓
Door maintenance agent		✓	✓	✓	✓
Lock and inlay maintenance agent 25 ml		✓	✓	✓	✓
Lock and inlay maintenance agent 100 ml		✓	✓	✓	✓
Lock and inlay maintenance agent 400 ml		✓	✓	✓	✓
A set of stainless steel cleaning agents, Gerda Inox-1, Inox- 2		✓	✓	✓	✓
GERDA RESIST ULTRA DUO tapes for layer sealing installation		✓	✓	✓	✓

# DIMENSIONS OF DOORS AND FRAMES

## NTT REVO DUOTHERM / ALUTHERM FRAME

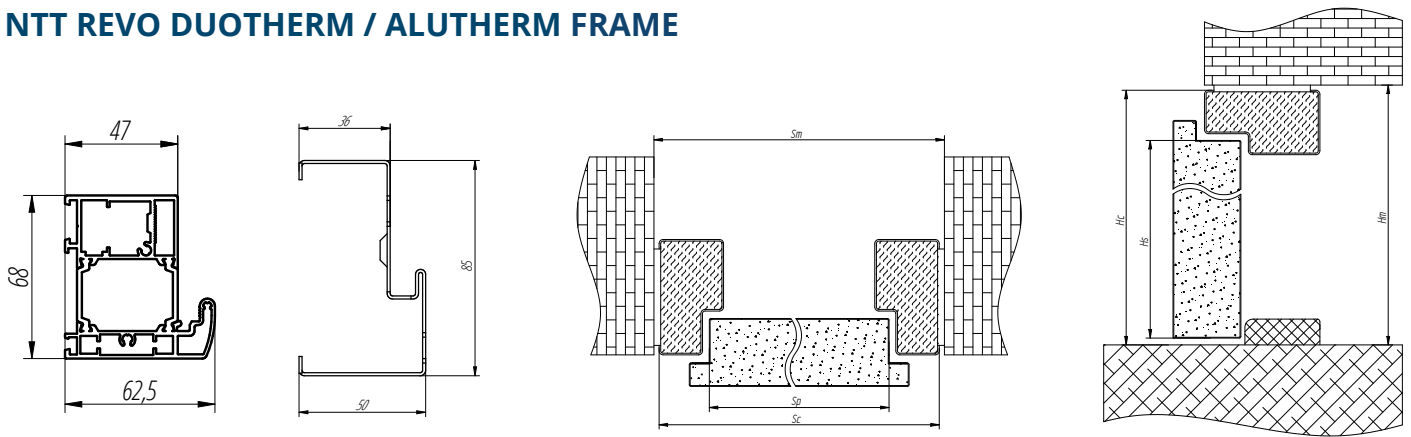

Size	Frame model	DOORS		FRAMES		RECOMMENDED ASSEMBLY OPENING*	
		Leaf height at the rabbet (Hs)	Leaf width at the rabbet (Sp)	Total frame height (Hc)	Total frame width (Sc)	Recommended height of the assembly opening measured from '0' level (Hm)	Recommended width of the assembly opening (Sm)
80	NTT 60/NTT 75 steel	2025 mm	812 mm	2076 mm	896 mm	2086 mm	916 mm
	NTT 60/NTT 75 aluminium	2025 mm	812 mm	2087 mm	918 mm	2097 mm	938 mm
90E	NTT 60/NTT 75 steel	2025 mm	925 mm	2076 mm	1009 mm	2086 mm	1029 mm
	NTT 60/NTT 75 aluminium	2025 mm	925 mm	2087 mm	1031 mm	2097 mm	1051 mm
100E	NTT 60/NTT 75 steel	2025 mm	1025 mm	2076 mm	1109 mm	2086 mm	1129 mm
	NTT 60/NTT 75 aluminium	2025 mm	1025 mm	2087 mm	1131 mm	2097 mm	1151 mm

\* includes an installation clearance of 10 mm

## TT OPTIMA FB / PERFOTHERM® / ALUTHERM OPTIMA FRAME

Size	Frame model	DOORS		FRAMES		RECOMMENDED ASSEMBLY OPENING*	
		Leaf height at the rabbet (Hs)	Leaf width at the rabbet (Sp)	Total frame height (Hc)	Total frame width (Sc)	Recommended height of the assembly opening measured from '0' level (Hm)	Recommended width of the assembly opening (Sm)
80N	TT Optima 50 FB	2025 mm	782 mm	2076 mm	866 mm	2086 mm	886 mm
	TT Optima 50 Perfotherm®						
	TT Optima 60 Perfotherm®						
80	TT Optima 50 FB	2025 mm	812 mm	2076 mm	896 mm	2086 mm	916 mm
	TT Optima 50 Perfotherm®			2087 mm	918 mm	2097 mm	938 mm
	TT Optima 60 Perfotherm®						
	TT OPTIMA 60 Alutherm						
90N	TT Optima 50 FB	2025 mm	882 mm	2076 mm	966 mm	2086 mm	986 mm
	TT Optima 50 Perfotherm®			2087 mm	988 mm		
	TT Optima 60 Perfotherm®						
	TT OPTIMA 60 Alutherm						
90E	TT Optima 50 FB	2025 mm	925 mm	2076 mm	1009 mm	2086 mm	1029 mm
	TT Optima 50 Perfotherm®			2087 mm	1031 mm	2097 mm	1051 mm
	TT Optima 60 Perfotherm®						
	TT OPTIMA 60 Alutherm						
100E	TT Optima 50 FB	2025 mm	1025 mm	2076 mm	1109 mm	2086 mm	1129 mm
	TT Optima 50 Perfotherm®			2087 mm	1131 mm	2097 mm	1151 mm
	TT Optima 60 Perfotherm®						
	TT OPTIMA 60 Alutherm						

\* includes an installation clearance of 10 mm

# DIMENSIONS OF DOORS AND FRAMES

## TT OPTIMA DUO PERFOTHERM® / ALUTHERM FRAME

SIZE	DOOR MODEL	LEAF, PASSIVE LEAF		PERFOTHERM FRAME		ALUTHERM FRAME		RECOMME-ED ASSEMBLY OPENING PERFOTHERM FRAME*		RECOMME-ED ASSEMBLY OPENING ALUTHERM OPTIMA FRAME *	
		Leaf height at the rabbet (Hs)	Leaf width at the rabbet (Sp)	Total frame height (Hc)	Total frame width (Sc)	Total frame height (Hc)	Total frame width (Sc)	Recommended height of the assembly opening measured from '0' level (Hm)	Recommended width of the assembly opening (Sm)	Recommended height of the assembly opening measured from '0' level (Hm)	Recommended width of the assembly opening (Sm)
30	TT OPTIMA DUO 60	2025	257	-	-	-	-	-	-	-	-
40			357								
50			457								
80	TT OPTIMA 60	2025	812	2076	896	2087	918	2086	916	2097	938
80+30	-		1196		1218		1238				
80+40	-		1296		1318		1338				
80+50	-		1396		1418		1438				
90 E	TT OPTIMA 60	2025	925	2076	1009	2087	1031	2086	1029	2097	1051
90 E +30	-		1309		1331		1351				
90 E +40	-		1409		1431		1451				
90 E +50	-		1509		1531		1551				
100 E	TT OPTIMA 60	2025	1025	2076	1109	2087	1131	2086	1129	2097	1151
100 E +30	-		1409		1431		1451				
100 E +40	-		1509		1531		1551				
100 E +50	-		1609		1631		1651				

\* includes an installation clearance of 10 mm

## TT OPTIMA FN FRAME

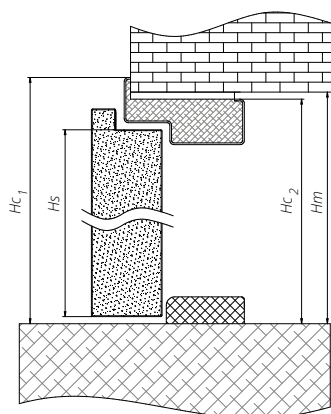
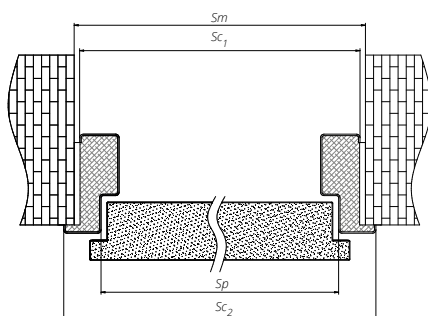
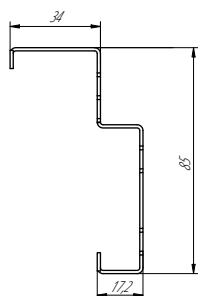

SIZE	DOORS		FRAMES				RECOMMENDED ASSEMBLY OPENING*	
	Leaf height at the rabbet (Hs)	Leaf width at the rabbet (Sp)	Frame height (Hc1)	Frame width (Hc2)	Frame width (Sc1)	Frame width (Sc2)	Recommended height of the assembly opening measured from '0' level (Hm)	Recommended width of the assembly opening (Sm)
80N	2025 mm	782 mm	2075 mm	2039 mm	797 mm	838 mm	2049 mm	817 mm
80	2025 mm	812 mm	2075 mm	2039 mm	829 mm	902 mm	2049 mm	849 mm
90E	2025 mm	925 mm	2075 mm	2039 mm	940 mm	981 mm	2049 mm	960 mm
100E	2025 mm	1025 mm	2075 mm	2039 mm	1040 mm	1081 mm	2049 mm	1060 mm

\* includes an installation clearance of 10 mm

## DOOR OPENING DIRECTIONS

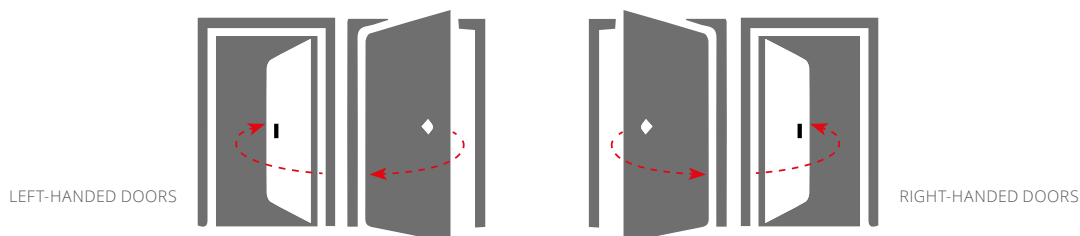

# GERDA LAYER SEALING INSTALLATION

## HEAT LOSS MINIMISATION

Layer sealing (commonly known as 'warm installation') is a technology enabling a durable and tight installation of doors. Using the layer sealing installation method significantly reduces heat losses and helps save on power bills.

Layer sealing installation is based on the use of three insulating layers with specific attributes:

- internal sealing – a vapour-tight tape used as a protective layer for thermal insulation, preventing the penetration of water vapour and humidity from the inside of the building into the insulation;
- middle layer – fitting foam used as thermal and acoustic insulation;
- external sealing – a vapour-permeable tape that prevents the penetration of humidity from the outside, while simultaneously diverting humidity from the building interior to the outside.

GERDA RESIST ULTRA DUO – recommended set of tapes for use in layer sealing installation.

GERDA RESIST ULTRA DUO tapes are recommended for use in door layer sealing installation; they are a modern product with a special membrane that regulate the diffusion of water through the compartment dilatation layer. A specially-prepared box contains two rolls of 8 linear metres of 90-mm-wide tape each, dedicated for the installation of a single door.

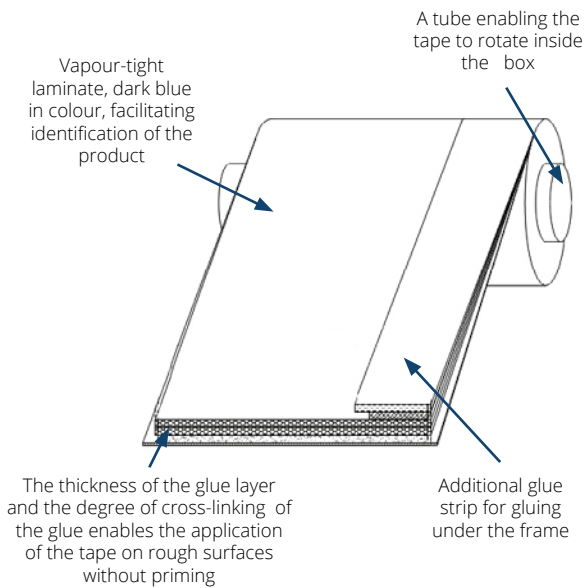

	EXTERNAL TAPE	INTERNAL TAPE
Length	8 m	8 m
Width	90 mm	90 mm
Glue layer	single	double

Set of GERDA RESIST ULTRA DUO tapes	✓
-------------------------------------	---



# GERDALOCK V3

Gerdalock V3 is a SMART HOME-type lock, enabling the automatic unlocking of doors without taking your smartphone out of your pocket.

## CHARACTERISTICS

- Equipped with an iBeacon Estimote Proximity, compatible with the application;
- can be installed on doors with pulls (ratchet pull function);
- safe, encrypted data transmission;
- easy and instant transfer of keys to other users (temporarily, regularly or permanently);
- ability to open the lock using an Apple Watch and Widget;
- option to receive notifications of each instance of unlocking and locking the door and access to an event log;
- ability to open the lock manually, using a knob from the inside and a key from the outside

## PRODUCT FEATURES

- the lock is powered by four CR123 batteries;
- GERDALOCK V3 is equipped with a clutch that activates only when the electric engine is working;
- Requirements of the GERDALOCK 2017 application: iPhone 5 with iOS10 or newer, or a phone with an Android 5.0 system or newer;
- the GERDALOCK V3 lock can be installed on doors with typical European profile inlays;
- a certified GERDA SLR FIX inlay, adapted to the lock, enables the door to be opened with a regular key;
- encrypted AES-256 data transmission ensures the highest level of security;
- the GERDALOCK 2017 application is available through App-Store and GooglePlay.



## SIZE DOORS

90 E | 100 E

MODEL	TT OPTIMA 50	TT OPTIMA 60	NTT REVO 60	NTT REVO 75
TT OPTIMA and NTT REVO accessory sets GERDA LOCK V3 BLUETOOTH	✓	✓	✓	✓
TT OPTIMA and NTT REVO accessory sets GERDA LOCK V3 BLUETOOTH + Z-Wave	✓	✓	✓	✓
	BLOK G-A	BLOK MC-C	BERGEN G-A	BERGEN MC-C
Main lock driver	SLR FIX	SLR FIX	SLR FIX	SLR FIX
Driver with an additional lock knob	WKE1	Mark100	WKE1	Mark100
BLOK / BERGEN unprotected escutcheon of the upper driver				
BLOK / BERGEN protected escutcheon of the main driver with handles				
decorative hinge covers in the same colour as the escutcheons				

\* optional accessories with TT OPTIMA, standard with NTT REVO.  
door pulls subject to an additional charge

ADDITIONAL ACCESSORIES		DESCRIPTION
Beacon Proximity	✓	Enables the use of the automatic opening function



# Security for the long term

[www.gerda.pl](http://www.gerda.pl)

This product catalogue does not constitute an offer within the meaning of legal regulations and is meant for reference only.

In order to ensure the highest quality of its products and services, Gerda reserves the right to implement changes in products without notice, which may not be included in this material due to the process of preparing printed materials.

Despite our best efforts to thoroughly review the information presented herein, factual or printing errors may occur.

Colours presented in the catalogue may differ from the actual colours of products due to differences in the technology of reproducing colours in the printing process.

Gerda Sp. z o.o. is the owner of copyrights to this catalogue and Gerda logos and graphical components.

Copying and distributing any content and materials without prior consent of Gerda Sp. z o.o. is prohibited.